

# HILTI

PD-I

English  
Français  
Español  
Português

en  
fr  
es  
pt



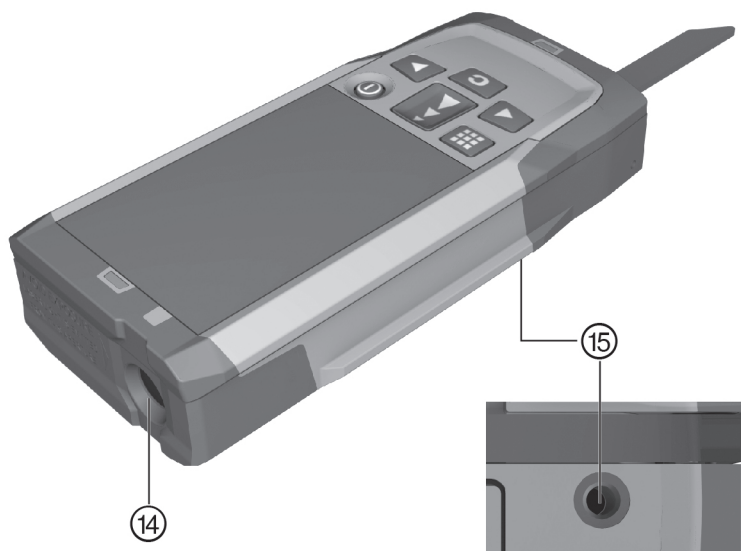
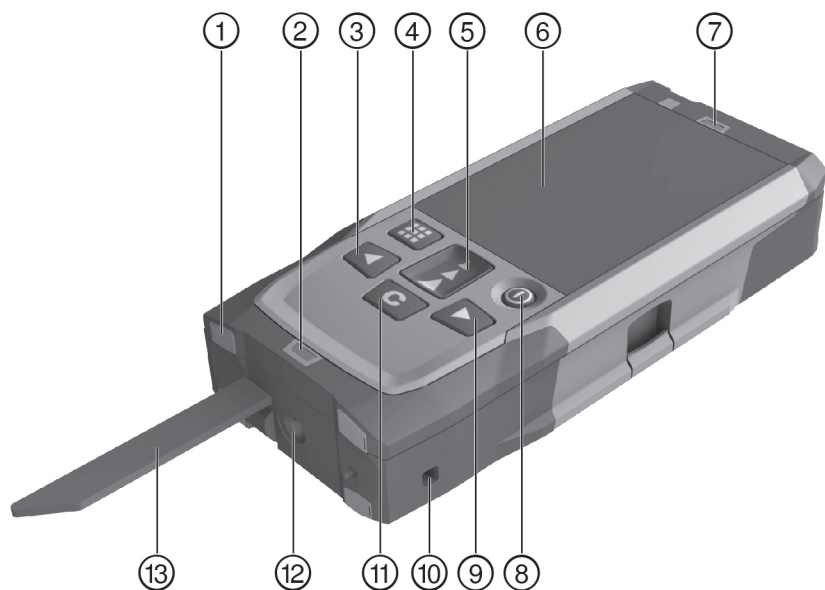

2

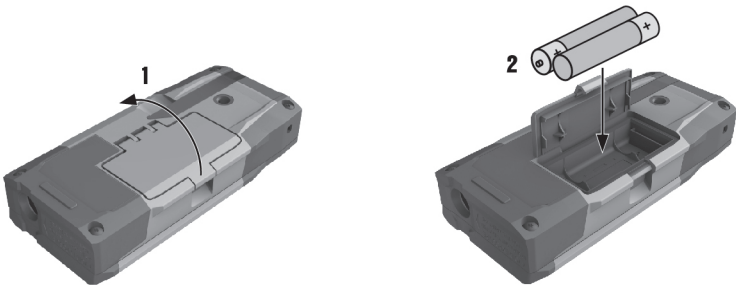

3

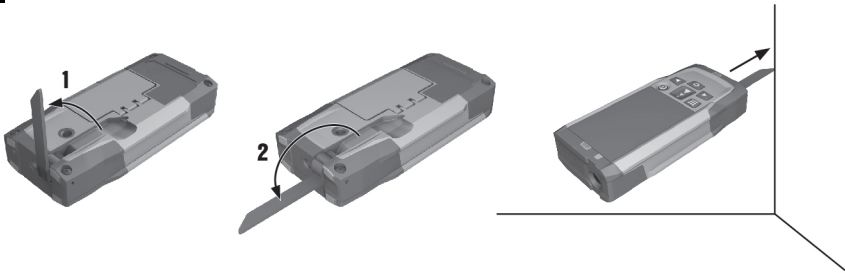

4

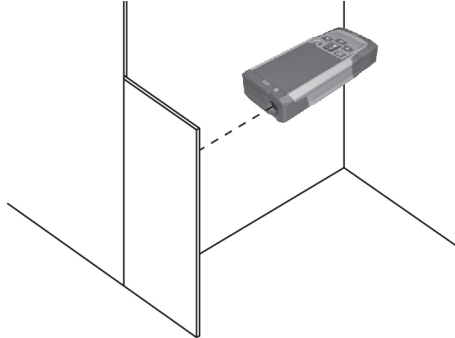

# PD-I



en	English .....	1
fr	Français .....	12
es	Español .....	23
pt	Português .....	34

## 1 Information about the documentation

### 1.1 Conventions







#### 1.1.1 Warning signs

The following warning signs are used:

	<b>DANGER!</b> Draws attention to imminent danger that will lead to serious personal injury or fatality.
	<b>WARNING!</b> Draws attention to a potentially dangerous situation that could lead to serious personal injury or fatality.
	<b>CAUTION!</b> Draws attention to a potentially dangerous situation that could lead to slight personal injury or damage to the equipment or other property.

#### 1.1.2 Symbols

The following symbols are used:

	Read the operating instructions before use.
	On/off button
	“Measure” button
	Menu button
	Delete (clear) button
	Right arrow button
	Left arrow button

#### 1.1.3 Typographical emphasis

The following typographic features are used to emphasize important passages in this technical documentation:

	These numbers refer to the corresponding illustrations.
---	---

### 1.2 About this documentation

- ▶ It is essential that the operating instructions are read before initial operation.
- ▶ **The information provided in the detailed operating instructions installed in the tool** as well as the supplements and updates provided at [www.hilti.com](http://www.hilti.com) must also be observed.
- ▶ Always keep these operating instructions together with the tool.
- ▶ Ensure that the operating instructions are with the tool when it is given to other persons.

### 1.3 Product information

Hilti products are designed for professional use and may be operated, serviced and maintained only by trained, authorized personnel. This personnel must be informed of any particular hazards that may be encountered. The product and its ancillary equipment may present hazards when used incorrectly by untrained personnel or when used not as directed.

The type designation and serial number are printed on the rating plate.

- ▶ Write down the serial number in the table below. You will be required to state the product details when contacting Hilti Service or your local Hilti organization to enquire about the product.

Product information → page 1

#### Product information



Laser range meter	PD-I
Generation	01

Serial no.	
------------	--

## 1.4 Laser information on the tool

Laser information → page 2

### Laser information

	<p>Laser Class 2 based on the IEC60825-1 / EN60825-1:2007 standard in compliance with CFR 21 § 1040 (Laser Notice 50).</p>
	<p>Laser Class 2: Do not stare into the beam. Do not direct the beam toward other persons or toward areas in which other persons, who are not involved in the work with lasers, may be present.</p>
	<p>Recycle waste material.</p>

## 2 Safety

### 2.1 Safety instructions

#### 2.1.1 Basic information concerning safety

In addition to the safety rules listed in the individual sections of these operating instructions, the following rules must be strictly observed at all times. The product and its ancillary equipment may present hazards when used incorrectly by untrained personnel or when used not as directed.

- ▶ Keep all safety instructions and information for future reference.
- ▶ Stay alert, watch what you are doing and use common sense when working with the product. Do not use the product while you are tired or under the influence of drugs, alcohol or medication. A moment of inattention while operating the product may result in serious personal injury.
- ▶ Do not render safety devices ineffective and do not remove information and warning notices.
- ▶ If the product is opened improperly, laser radiation in excess of Class 2 may be emitted. **Have the product repaired only by Hilti Service.**
- ▶ Tampering with or modification of the product is not permitted.
- ▶ Check that the product functions correctly each time before use.
- ▶ Measurements taken through panes of glass or other objects may be inaccurate.
- ▶ The measurement may be incorrect if the conditions under which the measurement is taken change rapidly, e.g. due to people walking through the path of the laser beam.
- ▶ Do not point the product toward the sun or other powerful light sources.
- ▶ Take the influences of the surrounding area into account. Do not use the tool where there is a risk of fire or explosion.
- ▶ Observe the information printed in the operating instructions concerning operation, care and maintenance.

#### 2.1.2 General safety rules

- ▶ Check the product for damage before use. Have the damage repaired by Hilti Service.
- ▶ Check the accuracy of the product after it has been dropped or subjected to other mechanical stresses.
- ▶ Although the product is designed for the tough conditions of jobsite use, as with other measuring instruments it should be treated with care.
- ▶ Products which are not in use must be stored in a dry, high place or locked away out of reach of children.
- ▶ The product is not intended for use by children.
- ▶ Observe the national health and safety requirements.

#### 2.1.3 Proper preparation of the working area

- ▶ Avoid unfavorable body positions when working from ladders. Make sure you have a safe stance and that you stay in balance at all times.
- ▶ Secure the site at which you are taking measurements and take care to avoid directing the laser beam toward other persons or toward yourself.

- ▶ When the product is brought into a warm environment from very cold conditions, or vice-versa, allow it to become acclimatized before use.
- ▶ Use the product only within its specified limits.
- ▶ Keep the laser exit window clean in order to avoid measurement errors.
- ▶ Observe the accident prevention regulations applicable in your country.

### 2.1.4 Working safely with laser tools

- ▶ Laser Class 2/Class II tools may be operated only by appropriately trained persons.
- ▶ Laser beams should not be projected at eye height.
- ▶ Precautions must be taken to ensure that the laser beam does not unintentionally strike highly reflective surfaces.
- ▶ Precautions must be taken to ensure that persons do not stare directly into the beam.
- ▶ The laser beam must not be allowed to project beyond the controlled area.
- ▶ Switch the laser tool off when it is not in use.
- ▶ Store laser tools, when not in use, in places to which unauthorized persons have no access.

### 2.1.5 Electromagnetic compatibility

Although the device complies with the strict requirements of the applicable directives, **Hilti** cannot entirely rule out the possibility of interference to the device caused by powerful electromagnetic radiation, possibly leading to incorrect operation. Check the accuracy of the device by taking measurements by other means when working under such conditions or if you are unsure. Likewise, **Hilti** cannot rule out the possibility of interference with other devices (e.g. aircraft navigation equipment). The tool complies with the requirements of class A; The possibility of interference occurring in a domestic environment cannot be excluded.

Only for Korea: This laser range meter is suitable for commercial and industrial use and for the electromagnetic radiation encountered in this field (Class A). Users must pay attention to this point and make sure that this laser range meter is not used in occupied living areas.

## 3 Description

### 3.1 Overview of the product

- |   |                                     |
|---|-------------------------------------|
| ① Rear contact surface                      | ⑨ Right arrow button                |
| ② Reference indicator LED for rear contact  | ⑩ Hand strap attachment point       |
| ③ Left arrow button                         | ⑪ Delete (clear) button             |
| ④ Menu button                               | ⑫ 1/4 inch thread                   |
| ⑤ "Measure" button                          | ⑬ Folding spike                     |
| ⑥ Graphic display                           | ⑭ Laser emitting and receiving lens |
| ⑦ Reference indicator LED for front contact | ⑮ 1/4 inch thread                   |
| ⑧ On/off button                             |                                     |

### 3.2 Intended use



The product described is a laser range meter. It is designed for taking individual measurements as well as the continuous measurement of distances.







Distances can be measured from all stationary targets without a highly reflective surface, i.e. concrete, stone, wood, plastic, paper, etc. The use of prisms or other highly reflective targets is not permissible and, if attempted, may falsify the results.

The product is approved for use with batteries of the type AAA.











### 3.3 Explanation of the display

#### Main menu





	Measure volumes
	Measure rectangular areas
	Select layout function

	Measure areas and volumes
	Select special functions
	Select trapezoid function
	Select Pythagoras function
	Select settings At least one right angle is required for horizontal and diagonal distances.
	Select indirect measuring No specific angle is required for measurements on non-moving objects such as walls.







#### Generally applicable symbols

	Battery charge state
	Measuring spike not folded out
	Measuring spike folded out
	Measuring
	Adding distances
	Subtracting distances
	Select
	Do not select
	Select measuring time
	Select calculator

#### Area and volume measurement submenu

	Measuring rectangular areas
	Measuring triangular areas
	Measuring volumes
	Measuring cylinder volume

#### Special functions submenu

	Select automatic brightness sensor
	Select min/max delta function
	Select layout function
	Determine painter's area
	Select timer
	Select offset function





	Select data storage media
--	---------------------------











### Trapezoid function submenu

	Measure 3 distances
	Measure 2 distances, 1 angle



### Pythagoras function submenu

	Single Pythagoras
	Double Pythagoras
	Combined Pythagoras

### Settings submenu

	Unit of measurement. Select unit of measurement: <b>m</b> meter <b>cm</b> centimeter <b>mm</b> millimeter
	Measuring references. Select measuring reference: <b>F</b> front edge <b>R</b> rear of thread <b>U</b> underside of thread
	Angle unit. Select angle unit: <b>%</b> inclination in percent <b>M</b> metric units <b>I</b> imperial units <b>D</b> inclination in angular degrees
	Select expert mode
	Edit favorites list
<b>1:X</b>	Activate scale
	Switching the signal tone on / off
	Select laser on constantly
	Select display inclination
	Calibrate inclination sensor
<b>i</b>	Display information about the tool
	Resetting to the default settings

### Indirect measurement submenu

	Indirect horizontal distance measurement
	Indirect vertical distance measurement
	Measurements on ceilings

## 3.4 Items supplied

Laser range meter, two batteries, operating instructions, manufacturer's certificate.

	<b>Note</b> You can find other system products approved for use with your product at your local <b>Hilti</b> Center or online at: <b>www.hilti.com</b> .
---	---

## 4 Technical data

<b>Battery life</b>	Room temperature: Up to 5000 measurements
<b>Operating temperature</b>	-10 °C ... 50 °C (14 °F ... 122 °F)
<b>Distance measurement accuracy (2<math>\sigma</math>, standard deviation)</b>	$\pm 1.0$ mm
<b>Inclination measurement accuracy (2<math>\sigma</math>, standard deviation)</b>	$\pm 0.2^\circ$
<b>Weight (including batteries)</b>	165 g (5.8 oz)
<b>Storage temperature</b>	-30 °C ... 70 °C (-22 °F ... 158 °F)
<b>Laser class in accordance with EN 60825-1:2007</b>	Laser class 2
<b>Protection class in accordance with IEC 60529</b>	IP 65
<b>Power source</b>	1.5 V

## 5 Operation

### 5.1 Basic functions

Navigate to the desired function with the aid of the left or right arrow buttons.

- ▶ Always press the "Measure" button to select a function.

### 5.2 Inserting the batteries



#### Note

Take care to ensure correct battery polarity. Change the batteries only in pairs. Do not use damaged batteries.

- ▶ Open the battery compartment and insert the batteries.

### 5.3 Switching the laser range meter on and off

1. If the tool is switched off, press the on/off button or the "Measure" button to switch it on.
2. If the tool is switched on, press the on/off button to switch it off.

### 5.4 Measuring using the spike

1. Fold out the spike through 90°. The spike can then be used as the contact point.



#### Note

Here, the spike helps to align the device while a stable position is established. This is the case primarily for indirect, trapezoid and Pythagoras measurements since these results are based on estimated values.

Use the measuring extension PDA 72 for inaccessible places. The device automatically detects the measuring extension. A confirmation window may appear in the display.

2. Fold out the spike through 180°. The measuring reference point is then set automatically.

### 5.5 Measuring using a target plate

1. Use the target plate to measure distance under the following unfavorable conditions:
  - ◀ The wall is not sufficiently reflective due to the type of surface.
  - ◀ The target point is not on a surface.
  - ◀ The distance to be measured is very long.
  - ◀ The light conditions are unfavorable (bright sunshine).
2. A distance of 1.2 mm should be added to the measured distance when using a target plate.

## 5.6 Single measurements

1. Press the “Measure” button briefly to activate the laser beam.
2. Keep the laser beam on the target point.
3. Press the “Measure” button briefly to take the measurement.
  - ◀ The measured distance is shown in the lower line of the display.
  - ◀ The distance measured in the previous measurement is shown in the upper line of the display.
4. To take another measurement, keep the laser beam on the target point and press the “Measure” button again.

## 5.7 Continuous measurement



### Note

During continuous measurement, 6-10 measurements are taken and displayed every second. The laser range meter can be moved relative to the target until the desired distance is reached.

1. Press the “Measure” button for 2 seconds.
  - ◀ If the signal tone is active, a signal tone will be emitted.
2. Move the laser range meter toward or away from the target until the desired distance is reached.
3. Press the “Measure” button briefly.
  - ◀ The measured distance is shown in the lower line of the display.
  - ◀ The distance measured in the previous measurement is shown in the upper line of the display.

## 5.8 Measuring volumes

1. Aim the tool at the target point and press the “Measure” button.
2. Aim the tool at the next target point and press the “Measure” button.
3. Aim the tool at the next target point and press the “Measure” button.

## 5.9 Measuring rectangular areas

1. Aim the tool at the target point for the room width and press the “Measure” button.
2. Aim the tool at the target point for the room length and press the “Measure” button.

## 5.10 Layout function

1. Enter the distance manually. Do this by using the left or right arrow buttons to select the keyboard symbol and confirm by pressing the “Measure” button.
2. Select the applicable numbers and confirm by pressing the “Measure” button.
3. To confirm the value, select the check mark symbol (tick) at the bottom right corner.
4. Select the flag symbol.
  - ◀ The distance you have entered will then be shown between the two flags.
5. Press the “Measure” button to begin measuring.
  - ◀ The arrows on the screen indicate in which direction you must move the tool. When the target distance is reached, black arrows appear above and below the distance shown in the display.
6. To repeat this distance measurement several times, move the tool further. The number of times you have measured out this distance is shown on the right of the screen.
7. Press the “Measure” button to stop measuring.



### Note

When the distance to be set out is reached, the currently used measuring reference is shown in the display.



### Note

As an alternative to entering the distance manually, the distance to be set out may also be measured with the tool. To do this, select the symbol for single measurement and confirm your choice by pressing the “Measure” button.

## 5.11 Special functions

### 5.11.1 Automatic brightness sensor

- ▶ Select the symbol for the automatic brightness sensor from the special functions menu.



#### Note

The automatic brightness sensor automatically dims the lighting on the display in dark surroundings. This saves battery power.

### 5.11.2 Min/max delta function

1. Select the symbol for the min/max delta function from the special functions menu.
2. Aim the tool at the target point and press the “Measure” button.
3. Press the “Measure” button to stop measuring.
  - ◀ The last distances measured are shown in the results line.

### 5.11.3 Painter’s area

1. Aim the tool at the target point for the first room length and press the “Measure” button.
  - ◀ The result is saved as an intermediate result.
2. Aim the tool at the target for the next room length and press the “Measure” button to take the measurement.
  - ◀ The second result is shown in the intermediate results table. The intermediate result shown in bold is the sum of the measured room lengths.
3. Repeat this procedure until all room lengths have been measured.
4. Press the right arrow button to switch to room height and confirm by pressing the “Measure” button.
5. Position and aim the tool for room height measurement and then take the measurement.
  - ◀ The room height is measured and displayed in the intermediate result line. The painter’s area is calculated immediately and shown in the result line.

### 5.11.4 Timer

1. Select the timer symbol from the special functions menu.
2. Set the timer to 2, 5 or 10 seconds and confirm by pressing the “Measure” button.
3. Select the “Measure” symbol to trigger the delayed measurement.

### 5.11.5 Data memory

1. Select the data storage symbol from the special functions menu.



#### Note

The tool can save up to 30 screens, including the graphical symbols. If 30 screens have already been saved, the oldest one will be deleted automatically when a new screen is saved.

2. To delete data storage memory, press and hold the C-button for 2 seconds while the data storage screen is displayed.

## 5.12 Trapezoid

### 5.12.1 Trapezoid function (3 distances)

1. Select the symbol for the trapezoid function for 3 distances from the trapezoid functions menu.
2. Aim the tool at the target point and press the “Measure” button.
  - ◀ After measuring the first distance, the graphical display automatically prompts you to take the next measurement.
3. Aim the tool at the next target point and press the “Measure” button.
4. Aim the tool at the third target point and press the “Measure” button.

### 5.12.2 Trapezoid with Inclination (2 distances, 1 angle)

1. Select the symbol for the trapezoid function with inclination from the trapezoid functions menu.
2. Aim the tool at the target point and press the “Measure” button.
3. Aim the tool at the next target point and press the “Measure” button.

## 5.13 Pythagoras

### 5.13.1 Single Pythagoras

1. Aim the tool at the target point and press the “Measure” button.
2. Aim the tool at the next target point and press the “Measure” button.



#### Note

In order to achieve accurate results, the second distance must be measured at right angles to the target distance.

### 5.13.2 Double Pythagoras

1. Aim the tool at the target point and press the “Measure” button.
2. Aim the tool at the next target point and press the “Measure” button.



#### Note

In order to achieve accurate results, the second distance must be measured at right angles to the target distance.

3. Aim the tool at the third target point and press the “Measure” button.

### 5.13.3 Combined Pythagoras

1. Aim the tool at the target point and press the “Measure” button.
2. Aim the tool at the next target point and press the “Measure” button.
3. Aim the tool at the next target point and press the “Measure” button.

## 5.14 Settings

### 5.14.1 Editing the favorites list

1. Navigate to the function that you wish to edit and confirm by pressing the “Measure” button.
2. Navigate to the desired function and confirm by pressing the “Measure” button.

### 5.14.2 Activating the scale

1. Set the applicable number and confirm the value by pressing the “Measure” button.
2. Select the check mark symbol (tick) to confirm the value.

### 5.14.3 Calibrate inclination sensor

1. Place the tool on a horizontal surface and press the “Measure” button.
2. Rotate the tool through 180° and press the “Measure” button.
  - ◀ The inclination sensor is now calibrated.

## 5.15 Indirect measurements

### 5.15.1 Indirect horizontal distance measurement

- ▶ Aim the tool at the target point and press the “Measure” button.
  - ◀ The distance and angle of inclination are measured and shown in the intermediate result line.
  - ◀ The target distance is calculated immediately and shown in the result line.

### 5.15.2 Indirect vertical distance (2 angles, 2 distances)

1. Aim the tool at the target point and press the “Measure” button.
  - ◀ The first distance and angle are measured and shown in the intermediate result line.
  - ◀ The graphical display automatically prompts you to measure the second distance.
2. Aim the tool at the next target point and press the “Measure” button.
  - ◀ The target distance is calculated immediately and shown in the result line.

### 5.15.3 Measuring on ceilings

1. Aim the tool at the target point and press the “Measure” button.
  - ◀ The first distance and angle are measured and shown in the intermediate result line.
  - ◀ The graphical display automatically prompts you to measure the second distance.

2. Aim the tool at the next target point and press the “Measure” button.
  - ◀ The target distance is calculated immediately and shown in the result line.

#### 5.15.4 Indirect vertical distance II (2 angles, 1 distance)

1. Aim the tool at the target point and press the “Measure” button.
  - ◀ The first distance and angle are measured and shown in the intermediate result line.
  - ◀ The graphical display automatically prompts you to measure the second distance.
2. Aim the tool at the next target point and press the “Measure” button.
  - ◀ The target distance is calculated immediately and shown in the result line.

## 6 Care, transport and storage

### 6.1 Cleaning

- ▶ Do not touch the lens with the fingers.
- ▶ Clean the lens by blowing the dust off or by wiping with a clean, dry cloth.
- ▶ Do not use liquids other than pure alcohol or water.

### 6.2 Transport



#### Note

The batteries must be insulated or removed from the product before it is shipped or sent by mail.

- ▶ Use the **Hilti** packaging or packaging of equivalent quality for transporting or shipping your equipment.

### 6.3 Storage and drying

- ▶ Do not put the product into storage when wet. Allow it to dry before putting it away.
- ▶ Observe the temperature limits given in the Technical Data section which are applicable to storage or transport of the equipment.
- ▶ Check the accuracy of the equipment before it is used after a long period of storage or transportation.

### 6.4 Disposal



#### WARNING

**Risk of injury.** Hazards presented by improper disposal.

- ▶ Improper disposal of the equipment may have the following consequences: The burning of plastic components generates toxic fumes which may present a health hazard. Batteries may explode if damaged or exposed to very high temperatures, causing poisoning, burns, acid burns or environmental pollution. Careless disposal may permit unauthorized and improper use of the equipment. This may result in serious personal injury, injury to third parties and pollution of the environment.

 Most of the materials from which **Hilti** products are manufactured can be recycled. The materials must be correctly separated before they can be recycled. In many countries, your old tools, machines or appliances can be returned to **Hilti** for recycling. Ask **Hilti** Service or your Hilti representative for further information.

In accordance with the European Directive on waste electrical and electronic equipment and its implementation in conformance with national law, electric tools or appliances that have reached the end of their life must be collected separately and returned to an environmentally compatible recycling facility.



- ▶ Disposal of electric tools or appliances together with household waste is not permissible.

## 7 FCC statement / IC statement

**CAUTION** This product has been tested and found to comply with the limits for a class B digital device, pursuant to part 15 of the FCC Rules. These limits are designed to provide reasonable protection against harmful interference in a residential installation. These products generate, use and can radiate radio frequency energy and, if not installed and used in accordance with the instructions, may cause interference to radio communications.

There is no guarantee that interference will not occur in a particular installation. If this product does cause harmful interference to radio or television reception, which can be determined by turning the product off and on, the user is encouraged to try to correct the interference by taking the following measures:

- ▶ Re-orient or move the receiving antenna.
- ▶ Increase the distance between the product and receiver.
- ▶ Connect the product to a power outlet on a circuit different from that to which the receiver is connected.
- ▶ Consult your dealer or an experienced TV/radio technician for assistance.

Changes or modifications not expressly approved by **Hilti** may restrict the user's right to operate the product. This product complies with the requirements in Paragraph 15 of the FCC Rules and RSS 210 of IC.

Operation of the product is subject to the following conditions:

- ▶ This product should cause no harmful interference.
- ▶ This product must accept any interference received, including interference that may cause undesired operation.

## **8 Manufacturer's warranty**

- ▶ Please contact your local **Hilti** representative if you have questions about the warranty conditions.



Hilti Corporation

LI-9494 Schaan

Tel.: +423/234 21 11

Fax: +423/234 29 65

[www.hilti.com](http://www.hilti.com)



2068385