

HILTI

PD 5

English
Français
Español

en
fr
es



1

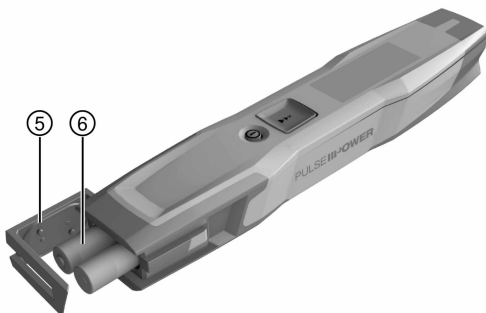
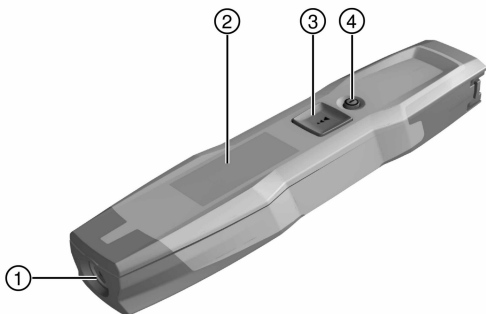

2

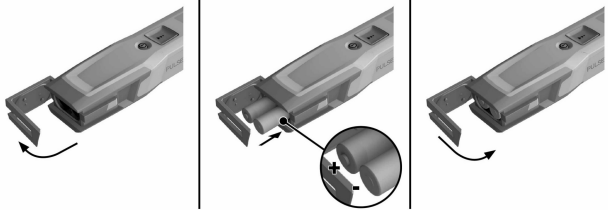

3



4



PD 5



en	Original operating instructions	1
fr	Mode d'emploi original	12
es	Manual de instrucciones original	24

1 Information about the documentation

1.1 Explanation of signs used





1.1.1 Warning signs

The following warning signs are used:

	DANGER! Draws attention to imminent danger that will lead to serious personal injury or fatality.
	WARNING! Draws attention to a potentially dangerous situation that could lead to serious personal injury or fatality.
	CAUTION! Draws attention to a potentially dangerous situation that could lead to slight personal injury or damage to the equipment or other property.



1.1.2 Symbols

The following symbols are used:

	Read the operating instructions before use.
	On/off button
	“Measure” button
	KCC-REM-HLT-PD5

1.1.3 Illustrations

The illustrations in these operating instructions are intended to promote a better understanding and may deviate from the actual version of the product.

	These numbers refer to the corresponding illustrations found at the beginning of these operating instructions.
3	The numbering in the illustrations reflects the order of the work steps in the illustration and may deviate from the numbering of work steps in the text.
	Item reference numbers are used in the overview illustration. In the product overview section, the numbers shown in the legend relate to these item reference numbers.

1.2 About this documentation

- ▶ Read these operating instructions before the product is used or operated for the first time. This is a prerequisite for safe, trouble-free handling and use of the product.
- ▶ Observe the safety instructions and warnings printed in this documentation and on the tool.

- ▶ Always keep the operating instructions with the tool and make sure that the operating instructions are with the tool when it is given to other persons.

We reserve the right to make changes. Errors excepted.

1.3 Product information

Hilti products are designed for professional use and may be operated, serviced and maintained only by trained, authorized personnel. This personnel must be informed of any particular hazards that may be encountered. The product and its ancillary equipment may present hazards when used incorrectly by untrained personnel or when used not as directed.

The type designation and serial number are printed on the type identification plate.



- ▶ Write down the serial number in the table below. You will be required to state the product details when contacting Hilti Service or your local Hilti organization to enquire about the product.

Product information

Laser range meter	PD 5
Generation	01
Serial no.	

1.4 Laser information on the product

Laser information

	<p>Laser Class 2 based on the IEC60825-1 / EN60825-1:2007 standard in compliance with CFR 21 § 1040 (Laser Notice 50).</p>
	<p>Laser Class 2: Do not stare into the beam. Do not direct the beam toward other persons or toward areas in which other persons, who are not involved in the work with lasers, may be present.</p>
	<p>This product may be used without need for further protective measures. The eyelid closure reflex protects the eyes when a person looks into the beam unintentionally for a brief moment. This eyelid closure reflex, however, may be negatively affected by medicines, alcohol or drugs. Nevertheless, as with the sun, one should not look directly into sources of bright light. Do not direct the laser beam toward persons.</p>

2 Safety

2.1 Safety instructions

2.1.1 Basic information concerning safety

In addition to the safety rules listed in the individual sections of these operating instructions, the following rules must be strictly observed at all times. The product and its ancillary equipment may present hazards when used incorrectly by untrained personnel or when used not as directed.

- ▶ Keep all safety instructions and information for future reference.
- ▶ Stay alert, watch what you are doing and use common sense when working with the product. Do not use the product while you are tired or under the influence of drugs, alcohol or medication. A moment of inattention while operating the product may result in serious personal injury.
- ▶ Do not render safety devices ineffective and do not remove information and warning notices.
- ▶ If the product is opened improperly, laser radiation in excess of Class 2 may be emitted. **Have the product repaired only by Hilti Service.**
- ▶ Tampering with or modification of the product is not permitted.
- ▶ Check that the product functions correctly each time before use.
- ▶ Measurements taken through panes of glass or other objects may be inaccurate.
- ▶ The measurement may be incorrect if the conditions under which the measurement is taken change rapidly, e.g. due to people walking through the path of the laser beam.
- ▶ Do not point the product toward the sun or other powerful light sources.
- ▶ Take the influences of the surrounding area into account. Do not use the tool where there is a risk of fire or explosion.
- ▶ Observe the information printed in the operating instructions concerning operation, care and maintenance.

2.1.2 General safety rules

- ▶ Check the product for damage before use. Have the damage repaired by **Hilti Service**.
- ▶ Check the accuracy of the product after it has been dropped or subjected to other mechanical stresses.
- ▶ Although the product is designed for the tough conditions of jobsite use, as with other measuring instruments it should be treated with care.
- ▶ Products which are not in use must be stored in a dry, high place or locked away out of reach of children.
- ▶ The product is not intended for use by children.
- ▶ Observe the national health and safety requirements.

2.1.3 Proper preparation of the working area

- ▶ Avoid unfavorable body positions when working from ladders. Make sure you have a safe stance and that you stay in balance at all times.
- ▶ Secure the site at which you are taking measurements and take care to avoid directing the laser beam toward other persons or toward yourself.
- ▶ When the product is brought into a warm environment from very cold conditions, or vice-versa, allow it to become acclimatized before use.
- ▶ Use the product only within its specified limits.
- ▶ Keep the laser exit window clean in order to avoid measurement errors.
- ▶ Observe the accident prevention regulations applicable in your country.

2.1.4 Laser classification

Depending on the version, the laser range meter complies with Laser Class 2 in accordance with IEC 60825-1:2007 /EN 60825-1:2007 and Class II in accordance with CFR 21 § 1040 (FDA). This tool may be used without need for further protective measures. The eyelid closure reflex protects the eyes when a person looks into the beam unintentionally for a brief moment. This eyelid closure reflex, however, may be negatively affected by medicines, alcohol or drugs. Nevertheless, as with the sun, one should never look directly into powerful sources of bright light. Do not direct the laser beam toward persons.

2.1.5 Electromagnetic compatibility

Although the device complies with the strict requirements of the applicable directives, **Hilti** cannot entirely rule out the possibility of interference to the device caused by powerful electromagnetic radiation, possibly leading to incorrect operation. Check the accuracy of the device by taking measurements by other means when working under such conditions or if you are unsure. Likewise, **Hilti** cannot rule out the possibility of interference with other devices (e.g. aircraft navigation equipment). The tool complies with the requirements of class A; The possibility of interference occurring in a domestic environment cannot be excluded.

Only for Korea: This laser range meter is suitable for commercial and industrial use and for the electromagnetic radiation encountered in this field (Class A). Users must pay attention to this point and make sure that this laser range meter is not used in occupied living areas.

3 Description

3.1 Overview of the product 1

- | | |
|-------------------------------------|-----------------------------|
| ① Laser emitting and receiving lens | ③ "Measure" button |
| ② Display | ④ On/off button |
| | ⑤ Battery compartment cover |
| | ⑥ Batteries |

3.2 Intended use

The product described is a laser range meter. It is designed for taking individual measurements as well as the continuous measurement of distances. Distances can be measured from all stationary targets without a highly reflective surface, i.e. concrete, stone, wood, plastic, paper, etc. The use of prisms or other highly reflective targets is not permissible and, if attempted, may falsify the results.

The product is approved for use with batteries of the type AAA.

3.3 Explanation of the display

Display

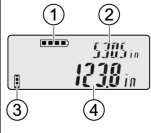
	<ol style="list-style-type: none">1. Battery charge state2. Last distance measured before the current measurement3. Current distance from continuous distance measurement or, respectively, the last measured distance.4. Error message
---	--

3.4 Items supplied

Laser range meter, 2 batteries, operating instructions, manufacturer's certificate



Note

To help ensure safe and reliable operation, use only genuine Hilti spare parts and consumables. Spare parts, consumables and accessories approved by Hilti for use with the product can be found at your local **Hilti Center** or online at: **www.hilti.com**

4 Technical data

	PD 5
Power source	1.5 V
Measuring range with target plate	0.25 m ... 100 m (0 ft - 9.8 in ... 328 ft)
Distance measurement accuracy	±1.5 mm + 20 ppm (±0.06 in + 20 ppm)
Calibration measuring area	1 m ... 5 m (3 ft ... 16 ft)
Protection class in accordance with IEC 60529	IP55
Operating temperature	-10 °C ... 50 °C (14 °F ... 122 °F)

	PD 5
Recommended temperature range for transport and storage	-30 °C ... 70 °C (-22 °F ... 158 °F)
Weight	100 g (3.5 oz)

5 Operation

5.1 Inserting the batteries



Note







Take care to ensure correct battery polarity. Change the batteries only in pairs. Do not use damaged batteries.

- ▶ Open the battery compartment and insert the batteries.

5.2 Fitting and removing the clip

1. Slide the clip on from the rear until it snaps into place.
2. Remove the clip by lifting it upwards.

5.3 Switching the laser range meter on and off

1. Press the  or  button.
 - ◁ The  and  buttons switch the laser range meter on.
 - ◁ The  button activates the laser.
2. When switched on, press the  button.
 - ◁ The laser range meter will be switched off.





Note



The laser switches itself off automatically after 1 minute.

The laser range meter switches itself off automatically after 10 minutes.

5.4 Switching the signal tone on/off

1. To activate the “Settings” menu, press and hold the  button for 2 seconds.
2. To switch the signal tone on or off, press the  button briefly.
3. After selecting the desired signal tone status, press the  button for 2 seconds.
 - ◁ All settings will be saved.
 - ◁ The laser range meter will be switched off.

5.5 Setting the unit of measure

1. To activate the “Settings” menu, press and hold the  button for 2 seconds.
2. Press the  button briefly to display the unit of measure settings function.

3. Press the **F** button to browse through the units of measure.
4. After selecting the unit of measure, press the **0** button for 2 seconds.
 - ◁ All settings will be saved.
 - ◁ The laser range meter will be switched off.

5.6 Switching on the display illumination



Note

The display illumination switches on automatically when the ambient light level is low.

- ▶ To switch on the display illumination, press the **0** or **F** button briefly.
 - ◁ The illumination switches off automatically after 20 seconds.

5.7 Single measurements

1. To activate the laser beam, press the **F** button briefly.
2. Keep the laser beam on the target point.
3. To take a measurement, press the **F** button briefly.
 - ◁ The measured distance is shown in the lower line of the display.
 - ◁ The distance measured in the previous measurement is shown in the upper line of the display.
4. To take an additional measurement, keep the laser on the target point and begin measuring by pressing the **F** button again.

5.8 Continuous measurement



Note

During continuous measurement, 8-15 measurements are taken and displayed every second. The laser range meter can be moved relative to the target until the desired distance is reached.

1. Press the **F** button for 2 seconds.
 - ◁ If the signal tone is active, a signal tone will be emitted.
2. Move the laser range meter toward or away from the target until the desired distance is reached.
3. Press the **F** button briefly.
 - ◁ The measured distance is shown in the lower line of the display.
 - ◁ The distance measured in the previous measurement is shown in the upper line of the display.

5.9 Measuring reference point **4**



Note

All measurements use the rear edge of the laser range meter as the reference point.

- ▶ Hold the rear edge of the laser range meter against the point from which the measurement is to be taken.

5.10 Hilti Measuring Systems Service

Hilti Measuring Systems Service checks the tool and, if deviations from the specified accuracy are found, recalibrates it and checks it again to ensure conformity with specifications. The service certificate provides written confirmation of conformity with specifications at the time of the test. The following is recommended:

- Choose a suitable test/inspection interval in accordance use of the tool.
- Have the product checked by **Hilti** Measuring Systems Service after exceptionally heavy use or subjection to unusual conditions or stress, before important work or at least once a year.

Having the product checked by **Hilti** Measuring Systems Service does not relieve the user of his/her obligation to check the product before and during use.

5.11 Checking accuracy

In order to ensure compliance with the technical specifications, the tool should be checked regularly (at least before each major / relevant measuring task).





After falling from considerable height, the tool should be checked for correct, accurate operation. When the following conditions are fulfilled it can be assumed that the tool is operating faultlessly:

- The height of the fall did not exceed the height given in the technical data.
- The tool operated faultlessly before the impact.
- The tool suffered no obvious mechanical damage from the impact (e.g. breakage of the pentaprism).

5.12 Troubleshooting

If the trouble you are experiencing is not listed in this table or you are unable to remedy the problem by yourself, please contact **Hilti** Service.

Trouble or fault	Possible cause	Action to be taken
The product can't be switched on.	The battery is discharged.	▶ Change the batteries in pairs.
	Batteries inserted incorrectly.	▶ Insert the batteries correctly. Take care to ensure correct polarity.
The measured distance is not shown.	"Measure" button was not pressed.	▶ Press the "Measure" button.

Trouble or fault	Possible cause	Action to be taken
The measured distance is not shown.	The display is faulty.	▶ Have the product repaired by Hilti Service .
	The target surface is too light, too dark or too reflective.	▶ Change the measuring direction so that light incidence is from the side. ▶ Use a target plate.
	The range meter is pointed toward the sun.	▶ Change the measuring direction so that the light comes from the side ▶ Use a target plate.
No measurement.	The target surface is too light, too dark or too reflective.	▶ Change the measuring direction so that light incidence is from the side. ▶ Use a target plate.
	The range meter is pointed toward the sun.	▶ Change the measuring direction so that the light comes from the side ▶ Use a target plate.
 Battery symbol	The battery is discharged.	▶ Change the batteries in pairs.
 Thermometer symbol.	The temperature is outside the permissible range.	▶ Allow the laser range meter to reach normal operating temperature.
 Telephone symbol.	General hardware fault.	▶ Switch the power tool off and then on again.
		▶ If the error message continues to be displayed, have the product repaired by Hilti Service .
 Cross hairs symbol.	Unfavorable conditions, poor signal.	▶ Stay within the distance measurement range. ▶ Use a target plate.

6 Care, transport and storage

6.1 Cleaning

- ▶ Do not touch the lens with the fingers.
- ▶ Clean the lens by blowing the dust off or by wiping with a clean, dry cloth.
- ▶ Do not use liquids other than pure alcohol or water.

6.2 Transport



Note

The batteries must be insulated or removed from the product before it is shipped or sent by mail.

- ▶ Use the **Hilti** packaging or packaging of equivalent quality for transporting or shipping your equipment.

6.3 Storage and drying

- ▶ Do not put the product into storage when wet. Allow it to dry before putting it away.
- ▶ Observe the temperature limits given in the Technical Data section which are applicable to storage or transport of the equipment.
- ▶ Check the accuracy of the equipment before it is used after a long period of storage or transportation.

7 Disposal



WARNING

Risk of injury. Hazards presented by improper disposal.

- ▶ Improper disposal of the equipment may have the following consequences: The burning of plastic components generates toxic fumes which may present a health hazard. Batteries may explode if damaged or exposed to very high temperatures, causing poisoning, burns, acid burns or environmental pollution. Careless disposal may permit unauthorized and improper use of the equipment. This may result in serious personal injury, injury to third parties and pollution of the environment.

 Most of the materials from which **Hilti** products are manufactured can be recycled. The materials must be correctly separated before they can be recycled. In many countries, your old tools, machines or appliances can be returned to **Hilti** for recycling. Ask **Hilti** Service or your Hilti representative for further information.

In accordance with the European Directive on waste electrical and electronic equipment and its implementation in conformance with national law, electric

tools or appliances that have reached the end of their life must be collected separately and returned to an environmentally compatible recycling facility.



- ▶ Disposal of electric tools or appliances together with household waste is not permissible.

8 FCC statement (applicable in US) / IC statement (applicable in Canada)

The product complies with part 15 of the FCC Rules and RSS-210 of the IC. Operation is subject to the following two conditions:

- This device shall cause no harmful interference.
- This device must accept any interference received, including interference that may cause undesired operation.



Note

Changes or modifications not expressly approved by **Hilti** may restrict the user's authorization to operate the equipment.

9 Manufacturer's warranty

- ▶ Please contact your local **Hilti** representative if you have questions about the warranty conditions.

HILTI

Hilti Corporation

LI-9494 Schaan

Tel.: +423/234 21 11

Fax: +423/234 29 65

www.hilti.com

