



ST 1800-A22

English

ST 1800-A22

Original operating instructions

1 Information about the documentation

1.1 About this documentation

- Read this documentation before initial operation or use. This is a prerequisite for safe, trouble-free handling and use of the product.
- Observe the safety instructions and warnings in this documentation and on the product.
- Always keep the operating instructions with the product and make sure that the operating instructions are with the product when it is given to other persons.

1.2 Explanation of symbols used

1.2.1 Warnings

Warnings alert persons to hazards that occur when handling or using the product. The following signal words are used:

DANGER

DANGER !

- ▶ Draws attention to imminent danger that will lead to serious personal injury or fatality.

WARNING

WARNING !

- ▶ Draws attention to a potential threat of danger that can lead to serious injury or fatality.





CAUTION

CAUTION !

- ▶ Draws attention to a potentially dangerous situation that could lead to slight personal injury or damage to the equipment or other property.





1.2.2 Symbols in the documentation

The following symbols are used in this document:

	Read the operating instructions before use.
	Instructions for use and other useful information
	Dealing with recyclable materials
	Do not dispose of electric equipment and batteries as household waste

1.2.3 Symbols in the illustrations

The following symbols are used in illustrations:

	These numbers refer to the corresponding illustrations found at the beginning of these operating instructions
	The numbering reflects the sequence of operations shown in the illustrations and may deviate from the steps described in the text
	Item reference numbers are used in the overview illustrations and refer to the numbers used in the product overview section
	This symbol is intended to draw special attention to certain points when handling the product.

1.3 Product-dependent symbols

1.3.1 Symbols on the product

The following symbols are used on the product:

	Forward / reverse
n_0	Rated speed under no load
RPM	Revolutions per minute
	Wireless data transfer

1.4 Product information

HILTI products are designed for professional users and only trained, authorized personnel are permitted to operate, service and maintain the products. This personnel must be specifically informed about the possible hazards. The product and its ancillary equipment can present hazards if used incorrectly by untrained personnel or if used not in accordance with the intended use.

The type designation and serial number are printed on the rating plate.

- ▶ Write down the serial number in the table below. You will be required to state the product details when contacting Hilti Service or your local Hilti organization to inquire about the product.

Product information

Cordless metal screwdriver	ST 1800-A22
Generation	01
Serial no.	

1.5 Declaration of conformity

We declare, on our sole responsibility, that the product described here complies with the applicable directives and standards. A copy of the declaration of conformity can be found at the end of this documentation.

The technical documentation is filed here:

Hilti Entwicklungsgesellschaft mbH | Tool Certification | Hiltistrasse 6 | 86916 Kaufering, Germany

2 Safety

2.1 General power tool safety warnings

⚠ WARNING Read all safety warnings, instructions, illustrations and specifications provided with this power tool. Failure to follow all instructions listed below may result in electric shock, fire and/or serious injury. **Save all warnings and instructions for future reference.**

The term "power tool" in the warnings refers to your mains-operated (corded) power tool or battery-operated (cordless) power tool.

Work area safety

- ▶ **Keep work area clean and well lit.** Cluttered or dark areas invite accidents.
- ▶ **Do not operate power tools in explosive atmospheres, such as in the presence of flammable liquids, gases or dust.** Power tools create sparks which may ignite the dust or fumes.
- ▶ **Keep children and bystanders away while operating a power tool.** Distractions can cause you to lose control.

Electrical safety

- ▶ **Power tool plugs must match the outlet. Never modify the plug in any way. Do not use any adapter plugs with earthed (grounded) power tools.** Unmodified plugs and matching outlets will reduce risk of electric shock.
- ▶ **Avoid body contact with earthed or grounded surfaces, such as pipes, radiators, ranges and refrigerators.** There is an increased risk of electric shock if your body is earthed or grounded.
- ▶ **Do not expose power tools to rain or wet conditions.** Water entering a power tool will increase the risk of electric shock.
- ▶ **Do not abuse the cord. Never use the cord for carrying, pulling or unplugging the power tool. Keep cord away from heat, oil, sharp edges or moving parts.** Damaged or entangled cords increase the risk of electric shock.

- ▶ **When operating a power tool outdoors, use an extension cord suitable for outdoor use.** Use of a cord suitable for outdoor use reduces the risk of electric shock.
- ▶ **If operating a power tool in a damp location is unavoidable, use a residual current device (RCD) protected supply.** Use of an RCD reduces the risk of electric shock.

Personal safety

- ▶ **Stay alert, watch what you are doing and use common sense when operating a power tool. Do not use a power tool while you are tired or under the influence of drugs, alcohol or medication.** A moment of inattention while operating power tools may result in serious personal injury.
- ▶ **Use personal protective equipment. Always wear eye protection.** Protective equipment such as a dust mask, non-skid safety shoes, hard hat or hearing protection used for appropriate conditions will reduce personal injuries.
- ▶ **Prevent unintentional starting. Ensure the switch is in the off-position before connecting to power source and/or battery pack, picking up or carrying the tool.** Carrying power tools with your finger on the switch or energising power tools that have the switch on invites accidents.
- ▶ **Remove any adjusting key or wrench before turning the power tool on.** A wrench or a key left attached to a rotating part of the power tool may result in personal injury.
- ▶ **Do not overreach. Keep proper footing and balance at all times.** This enables better control of the power tool in unexpected situations.
- ▶ **Dress properly. Do not wear loose clothing or jewellery. Keep your hair, clothing and gloves away from moving parts.** Loose clothes, jewellery or long hair can be caught in moving parts.
- ▶ **If devices are provided for the connection of dust extraction and collection facilities, ensure these are connected and properly used.** Use of dust collection can reduce dust-related hazards.
- ▶ **Do not let familiarity gained from frequent use of tools allow you to become complacent and ignore tool safety principles.** A careless action can cause severe injury within a fraction of a second.

Power tool use and care

- ▶ **Do not force the power tool. Use the correct power tool for your application.** The correct power tool will do the job better and safer at the rate for which it was designed.
- ▶ **Do not use the power tool if the switch does not turn it on and off.** Any power tool that cannot be controlled with the switch is dangerous and must be repaired.
- ▶ **Disconnect the plug from the power source and/or remove the battery pack, if detachable, from the power tool before making any adjustments, changing accessories, or storing power tools.** Such preventive safety measures reduce the risk of starting the power tool accidentally.
- ▶ **Store idle power tools out of the reach of children and do not allow persons unfamiliar with the power tool or these instructions to operate the power tool.** Power tools are dangerous in the hands of untrained users.
- ▶ **Maintain power tools and accessories. Check for misalignment or binding of moving parts, breakage of parts and any other condition that may affect the power tool's operation. If damaged, have the power tool repaired before use.** Many accidents are caused by poorly maintained power tools.
- ▶ **Keep cutting tools sharp and clean.** Properly maintained cutting tools with sharp cutting edges are less likely to bind and are easier to control.
- ▶ **Use the power tool, accessories and tool bits etc. in accordance with these instructions, taking into account the working conditions and the work to be performed.** Use of the power tool for operations different from those intended could result in a hazardous situation.
- ▶ **Keep handles and grasping surfaces dry, clean and free from oil and grease.** Slippery handles and grasping surfaces do not allow for safe handling and control of the tool in unexpected situations.

Battery tool use and care

- ▶ **Recharge only with the charger specified by the manufacturer.** A charger that is suitable for one type of battery pack may create a risk of fire when used with another battery pack.
- ▶ **Use power tools only with specifically designated battery packs.** Use of any other battery packs may create a risk of injury and fire.
- ▶ **When battery pack is not in use, keep it away from other metal objects, like paper clips, coins, keys, nails, screws or other small metal objects, that can make a connection from one terminal to another.** Shorting the battery terminals together may cause burns or a fire.
- ▶ **Under abusive conditions, liquid may be ejected from the battery; avoid contact. If contact accidentally occurs, flush with water. If liquid contacts eyes, additionally seek medical help.** Liquid ejected from the battery may cause irritation or burns.
- ▶ **Do not use a battery pack or tool that is damaged or modified.** Damaged or modified batteries may exhibit unpredictable behaviour resulting in fire, explosion or risk of injury.

- ▶ **Do not expose a battery pack or tool to fire or excessive temperature.** Exposure to fire or temperature above 130° C (265 °F) may cause explosion.
- ▶ **Follow all charging instructions and do not charge the battery pack or tool outside the temperature range specified in the instructions.** Charging improperly or at temperatures outside the specified range may damage the battery and increase the risk of fire.

Service

- ▶ **Have your power tool serviced by a qualified repair person using only identical replacement parts.** This will ensure that the safety of the power tool is maintained.
- ▶ **Never service damaged battery packs.** Service of battery packs should only be performed by the manufacturer or authorized service providers.

2.2 Drill/driver safety warnings

- ▶ **Hold the power tool by insulated gripping surfaces, when performing an operation where the fastener may contact hidden wiring.** Fasteners contacting a "live" wire may make exposed metal parts of the power tool "live" and could give the operator an electric shock.

2.3 Additional safety precautions for screwdrivers

Personal safety

- ▶ Use the product only when it is in perfect working order.
- ▶ Never tamper with or modify the tool in any way.
- ▶ Use the auxiliary grips supplied with the power tool. Loss of control can cause personal injury.
- ▶ Always hold the tool firmly with both hands on the grips provided. Keep the grips clean and dry.
- ▶ Do not touch rotating parts – risk of injury!
- ▶ Wear suitable protective glasses, a hard hat, ear protection, protective gloves and light respiratory protection while using the power tool.
- ▶ Wear protective gloves also when changing the tool. Touching the accessory tool can result in cuts and burns.
- ▶ Wear eye protection. Flying fragments can injure the body and eyes.
- ▶ Before starting work, check the hazard class of the dust that will be produced when working. Use an industrial vacuum cleaner with an officially approved protection class in compliance with the locally applicable dust protection regulations. Dust from materials such as lead-based paint, certain types of wood and concrete/masonry/stone containing quartz, minerals or metal can be harmful to health.
- ▶ Make sure that the workplace is well ventilated and, where necessary, wear a respirator appropriate for the type of dust generated. Contact with or inhalation of the dust may cause allergic reactions and/or respiratory or other diseases among operators or bystanders. Certain kinds of dust are classified as carcinogenic such as oak and beech dust, especially in conjunction with additives for wood conditioning (chromate, wood preservative). Only specialists are permitted to handle material containing asbestos.
- ▶ Take breaks and do physical exercises to improve the blood circulation in your fingers. Exposure to vibration during long periods of work can lead to disorders of the blood vessels and nervous system in the fingers, hands and wrists.

Electrical safety

- ▶ Before beginning work, check the working area for concealed electric cables or gas and water pipes. External metal parts of the power tool may give you an electric shock if you damage an electric cable accidentally.

Power tool use and care

- ▶ Immediately switch off the power tool if the accessory tool jams. The power tool might twist off-line.
- ▶ Wait until the power tool stops completely before you lay it down.

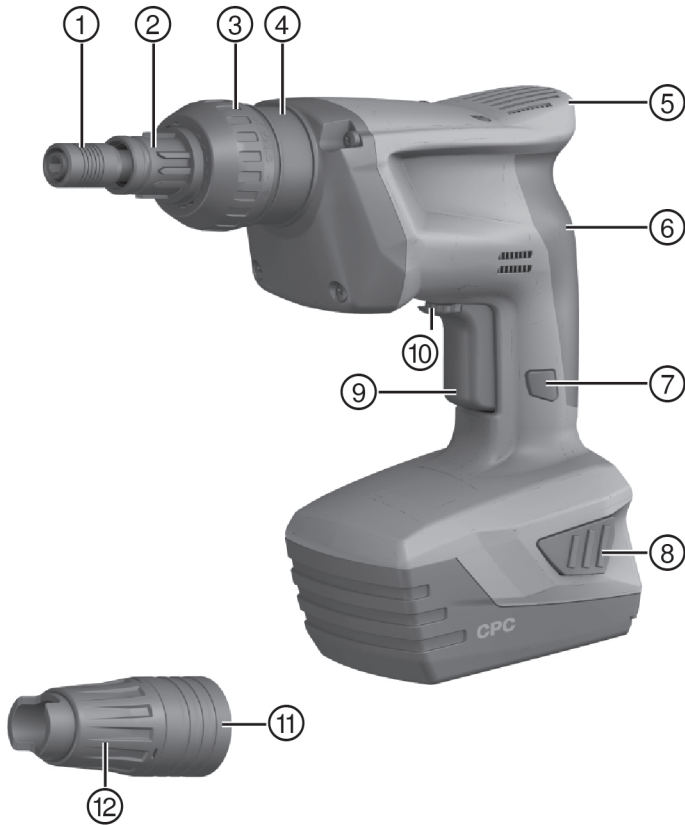
3 Description**3.1 Overview of the product**

- | | |
|---|--|
| ① Chuck | ⑦ Lockbutton |
| ② Protective cap | ⑧ Release button with additional function (charge status display activation) |
| ③ Torque adjustment | ⑨ Control switch |
| ④ Power tool / accessory interface (snap-on connection) | ⑩ Forward / reverse switch |
| ⑤ Pressure transfer surface | ⑪ Depth gauge |
| ⑥ Grip | ⑫ Depth gauge adjustment |

3.2 Intended use

The product described is a hand-held cordless screwdriver for fastening profile metal sheets, metal sheets and sandwich panels in metal construction. The product is designed for driving and removing self-drilling and self-tapping screws in appropriate materials and material thicknesses.

It is possible to use a stand-up tool for driving collated screws.

- ▶ Use only **Hilti** Li-ion batteries of the B 22 series with this product.
- ▶ Use only **Hilti** battery chargers of the C4/36 series for charging these batteries.

3.3 Items supplied

Metal construction screwdriver, ST-DG 19 depth gauge, ST-DC protective cap, S-NSD 8 screwdriving bit, operating instructions.

Spare parts, consumables and accessories approved by Hilti for use with the product can be found at your local **Hilti Store** or online at: www.hilti.group.

3.4 Li-ion battery display

The charge status of the Li-ion battery and malfunctions of the power tool are indicated by the display on the Li-ion battery. The charge status of the Li-ion battery is displayed after pressing one of the two battery release buttons.

Status	Meaning
4 LEDs light.	Charge status: 75 % to 100 %
3 LEDs light.	Charge status: 50 % to 75 %
2 LEDs light.	Charge status: 25 % to 50 %
1 LED lights.	Charge status: 10 % to 25 %
1 LED blinks, the power tool is ready for use.	Charge status: < 10 %
1 LED blinks, the power tool is not ready for use.	The battery has overheated.
4 LEDs blink, the power tool is not ready for use.	The power tool is overloaded or has overheated.

Battery charge state cannot be displayed while the control switch is pressed and for up to 5 seconds after releasing the control switch. If the battery display LEDs blink, please observe the instructions given in the Troubleshooting section.

4 Technical data

4.1 Cordless metal screwdriver

Rated voltage	21.6 V _{DC}
Weight in accordance with EPTA procedure 01/2003	3.1 kg
Rated speed under no load	2,000 /min
Torque	12 Nm
Socket/bit drive	1/4" hex. socket with locking ring
Operating temperature	-17 °C ... 60 °C
Storage temperature range (without battery)	-20 °C ... 70 °C

4.2 Battery

Battery operating voltage	21.6 V
Ambient temperature for operation	-17 °C ... 60 °C
Storage temperature	-20 °C ... 40 °C
Battery charging starting temperature	-10 °C ... 45 °C

4.3 Noise information and vibration values in accordance with EN 62841

The sound pressure and vibration values given in these instructions were measured in accordance with a standardized test and can be used to compare one power tool with another. They can also be used for a preliminary assessment of exposure.

The data given represent the main applications of the power tool. However, if the power tool is used for different applications, with different accessory tools, or is poorly maintained, the data can vary. This can significantly increase exposure over the total working period.

An accurate estimation of exposure should also take into account the times when the tool is switched off, or when it is running but not actually being used for a job. This can significantly reduce exposure over the total working period.

Identify additional safety measures to protect the operator from the effects of noise and/or vibration, for example: maintaining the power tool and accessory tools, keeping the hands warm, organization of work patterns.

Noise emission values determined in accordance with EN 62841

Sound (power) level (L_{WA})	81 dB(A)
Uncertainty for the sound power level (K_{WA})	3 dB(A)
Emission sound pressure level (L_{pA})	70 dB(A)
Uncertainty for the sound pressure level (K_{pA})	3 dB(A)

Total vibration (vector sum of three directions), measured in accordance with EN 62841

Screwdriving (a_n)	0.5 m/s ²
Uncertainty for screwdriving (K)	1.5 m/s ²

5 Operation

5.1 Charging the battery

1. Before charging the battery, read the operating instructions for the charger.
2. Make sure that the contacts on the battery and the contacts on the charger are clean and dry.
3. Use an approved charger to charge the battery.

5.2 Inserting the battery

WARNING

Risk of injury! Inadvertent starting of the impact screwdriver.

- ▶ Before fitting the battery, check that the cordless impact screwdriver is switched off and that the forward/reverse switch is in the middle position (i.e. safety lock engaged).

WARNING

Electrical hazards! Risk of short circuiting.

- ▶ Before inserting the battery, check to ensure that the battery terminals and the contacts in the impact screwdriver are free from foreign objects.

WARNING

Risk of injury! Hazard presented by a falling battery.

- ▶ A falling battery may present a risk of injury to yourself and others. Check that the battery is securely seated in the power tool.

- i** Make sure that the outer surfaces of the battery are clean and dry before inserting the battery in an approved battery charger.



- Push the battery into the product from the rear as far as it will go and until it is heard to engage with a double click.

5.3 Removing the battery



- Remove the battery.

5.4 Fitting / removing the depth gauge (optional)

- i** When driving screws with a sealing washer, use a depth gauge suitable for the diameter of the sealing washer (accessory). When the depth gauge is correctly adjusted the screw seal will be correctly compressed.

The depth gauge is attached to the metal construction screwdriver by way of a snap-on connection and can be simply pulled off or pushed on.



- ▶ Fit the depth gauge.

5.5 Using the protective cap



When the depth gauge is not fitted, the guard protects the depth gauge holder from dirt and damage.



- ▶ Use the protective cap.

5.6 Setting forward or reverse rotation



An interlock prevents switching while the motor is running.

The control switch is locked when the forward/reverse switch is in the middle position (safety lock).



- ▶ Set the forward/reverse switch to the desired direction of rotation.

5.7 Setting the torque



- ▶ Set the desired torque.

5.8 Safe operation

WARNING

Electric shock A fastener coming into contact with a concealed electric cable may result in electric shock.

- ▶ **Never use the depth gauge or chuck as a gripping area.**



Always hold the tool by the grip and/or with the hands on plastic parts of the casing (in-line grip).

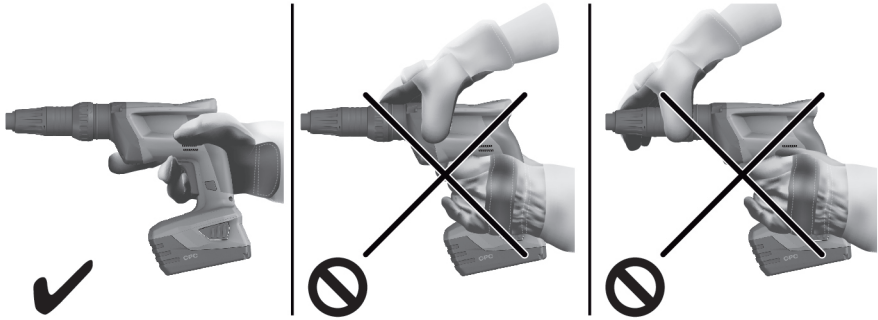

- ▶ Always hold the tool by the grip and/or with the hands on plastic parts of the casing.

5.9 Switching on

i The metal construction screwdriver must be pressed lightly against the working surface as it will otherwise not start (for safety reasons). The running speed can be controlled smoothly right up to maximum speed by varying how far the control switch is pressed in.

- ▶ Switch the tool on.

5.10 Switching on in sustained operating mode

i The lockbutton can be pressed in while the control switch is pressed. The metal construction screwdriver then runs in sustained operating mode. The lockbutton makes the tool less tiring to use as the control switch does not have to be constantly pressed.



- ▶ Switch on in sustained operating mode.

5.11 Switching off after sustained operation

i In order to be able to switch off from sustained operating mode quickly at any time, keep your hand close to the control switch. Pressing the control switch again causes the lockbutton to jump back into its original position.



- ▶ Switch off after sustained operation.

5.12 Removing screws



Remove the depth gauge or screw guide, if fitted. Set the forward / reverse switch to the “Reverse” position.

- ▶ Remove the screws.

6 Care and maintenance



WARNING

Risk of injury with battery inserted !

- ▶ Always remove the battery before carrying out care and maintenance tasks!

Care and maintenance of the tool

- Carefully remove stubborn dirt.
- Clean the air vents carefully with a dry brush.
- Use only a slightly damp cloth to clean the casing. Do not use cleaning agents containing silicone as these can attack the plastic parts.

Care of the Li-ion batteries

- Keep the battery free from oil and grease.
- Use only a slightly damp cloth to clean the casing. Do not use cleaning agents containing silicone as these may attack the plastic parts.
- Avoid ingress of moisture.

Maintenance

- Check all visible parts and controls for signs of damage at regular intervals and make sure that they all function correctly.
- Do not operate the product if signs of damage are found or if parts malfunction. Have it repaired immediately by **Hilti Service**.
- After cleaning and maintenance, fit all guards or protective devices and check that they function correctly.



To help ensure safe and reliable operation, use only genuine Hilti spare parts and consumables. Spare parts, consumables and accessories approved by Hilti for use with the product can be found at your local **Hilti Store** or online at: www.hilti.group.

7 Transport and storage of cordless tools

Transport



CAUTION

Accidental starting during transport !

- ▶ Always transport your products with the batteries removed!

- ▶ Remove the battery.
- ▶ Never transport batteries in bulk form (loose, unprotected).
- ▶ Check the tool and batteries for damage before use after long periods of transport.

Storage

CAUTION

Accidental damage caused by defective or leaking batteries !

- ▶ Always store your products with the batteries removed!
-
- ▶ Store the tool and batteries in a place that is as cool and dry as possible.
 - ▶ Never store batteries in direct sunlight, on heating units or behind a window pane.
 - ▶ Store the tool and batteries in a place where they cannot be accessed by children or unauthorized persons.
 - ▶ Check the tool and batteries for damage before use after long periods of storage.

8 Troubleshooting

If the trouble you are experiencing is not listed in this table or you are unable to remedy the problem by yourself, please contact **Hilti Service**.

8.1 The metal construction screwdriver is not operational.

Trouble or fault	Possible cause	Action to be taken
The metal construction screwdriver doesn't start.	The battery is not fully inserted.	▶ Push the battery in until it engages with an audible click.
	The battery is discharged.	▶ Charge the battery.
	Electrical fault.	▶ Switch the metal construction screwdriver off immediately, remove the battery, keep it under observation, allow it to cool down and contact HiltiService .
The control switch can't be pressed, i.e. the switch is locked.	The forward / reverse switch is in the middle position.	▶ Push the forward / reverse switch to the left or right.
The battery is not heard to engage.	The retaining lugs on the battery are dirty.	▶ Clean the retaining lugs and push the battery in until it engages. Contact Hilti Service if the problem persists.
LED 1 blinks.	The battery is discharged.	▶ Charge the battery.
	The battery is too hot.	▶ Bring the battery to the recommended operating temperature.
	The battery is too cold.	▶ Bring the battery to the recommended operating temperature.
The screwdriver doesn't work and all four LEDs blink.	The product is overloaded (application limits exceeded).	▶ Release the control switch and then press it again. Reduce the load on the tool.

8.2 The metal construction screwdriver is operational.

Trouble or fault	Possible cause	Action to be taken
Speed of rotation drops considerably.	The battery is discharged.	▶ Charge the battery.
The metal construction screwdriver or battery gets very hot.	Electrical fault.	▶ Switch the metal construction screwdriver off immediately, remove the battery, keep it under observation, allow it to cool down and contact HiltiService .

Trouble or fault	Possible cause	Action to be taken
The screw is pressed too tightly against the surface.	The depth gauge is set incorrectly.	▶ Turn the depth gauge to the right.
The screw is not pressed tightly enough against the surface.	The depth gauge is set incorrectly.	▶ Turn the depth gauge to the left.
The screwdriver runs but the screw can't be driven.	The wrong direction of rotation is set.	▶ Set the forward/reverse switch to the desired direction of rotation.

9 Disposal

Most of the materials from which **Hilti** tools and appliances are manufactured can be recycled. The materials must be correctly separated before they can be recycled. In many countries, your old tools, machines or appliances can be returned to **Hilti** for recycling. Ask **Hilti** Service or your Hilti representative for further information.

Battery disposal

Improper disposal of batteries can result in health hazards from leaking gases or fluids.

- ▶ DO NOT send batteries through the mail!
- ▶ Cover the terminals with a non-conductive material (such as electrical tape) to prevent short circuiting.
- ▶ Dispose of your battery out of the reach of children.
- ▶ Dispose of the battery at your **Hilti Store**, or consult your local governmental garbage disposal or public health and safety resources for disposal instructions.



- ▶ Do not dispose of power tools, electronic equipment or batteries as household waste!

10 RoHS (Restriction of Hazardous Substances)

Click on the links to go to the table of hazardous substances: qr.hilti.com/r/5036

There is a link to the RoHS table, in the form of a QR code, at the end of this document.

11 Manufacturer's warranty

- ▶ Please contact your local **Hilti** representative if you have questions about the warranty conditions.



Hilti Corporation
Feldkircherstraße 100
9494 Schaan | Liechtenstein

ST1800-A22 (01)

[2009]

2006/42/EC

EN ISO 12100

2014/30/EU

EN 62841-1

2011/65/EU

EN 62841-2-2

2001/14/EC

Schaan, 2018-09-20

Norbert Wohlwend

Head of BU Quality Management
DQX Quality Management Direct
Fastening

Lars Tänzer

Head of BU Direct Fastening
BU Direct Fastening

ROHS





Hilti Corporation
LI-9494 Schaan
Tel.:+423 234 21 11
Fax:+423 234 29 65
www.hilti.group