

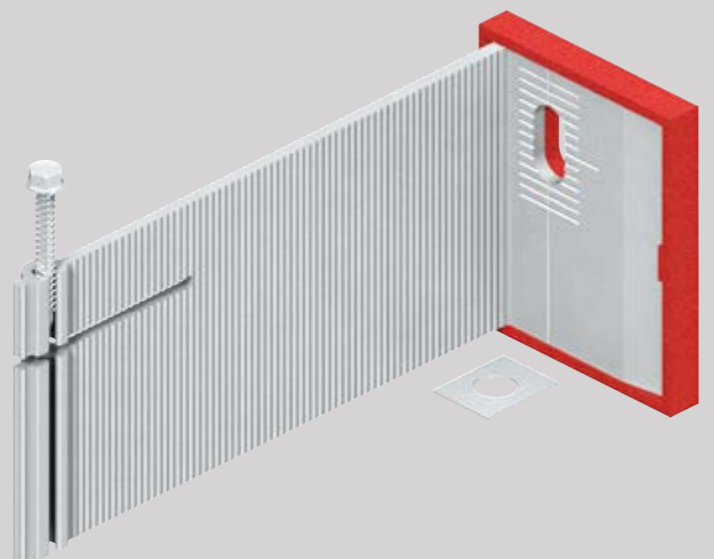

MFT-FOX-HI-2L- ADHESIVE-RIVETS- SCREWS-WIND- MEMBRANE

Hilti facade system



CONTENT AND OVERVIEW

Panels	3
Application and Description	4
System Drawings	5-18
Brackets Range	
MFT-FOX HI Medium	19-20
Bracket Profile Adjustment	21
Products Range	22-23

MFT-FOX-HI-2L-adhesive-rivets-screws-wind-membrane



Fiber-cement



HPL



Metal



Render



Ceramic



Composite





APPLICATION AND DESCRIPTION

MFT-FOX-HI-2L-adhesive-rivets-screws-wind-membrane

Aluminum system for horizontal sub constructions in rain screen facades.

The bracket MFT-FOX H/Hi is specially design for the use in horizontal sub constructions in rain screen facades. The vertical alignment of the bracket guaranties an optimal load transfer to the base material. Additionally the bracket is easy to install in one layer horizontal solution as well as in double layer solutions.

Fix- and flexible point are no longer needed with this bracket as the thermal expansion of the profiles is absorbed by the bracket. Therefore the installation of the bracket is not just easier but also saver. Wrong mounted fix- and flexible point are belonging to the past.

Advantages:

- No need for fix- and flexible point
- No different bracket sizes
- Bracket length from 55 mm up to 300 mm in steps of 20 mm enabling always the right bracket length for your facade
- Thermal separation due to pre-mounted isolator (FOX HI)
- Up to 40 mm profile adjustment flexibility
- Pre mounted A4 screw for fixing the profile
- Full flexibility of mounting material- Anchors, direct- and screw fastening possible
- Suitable for all common base materials
- Individual calculation with Profis software guaranties a technical and economical optimized solution
- Use of all common claddings possible
- Easy to use with windfoil

VIEW OF CLADDING

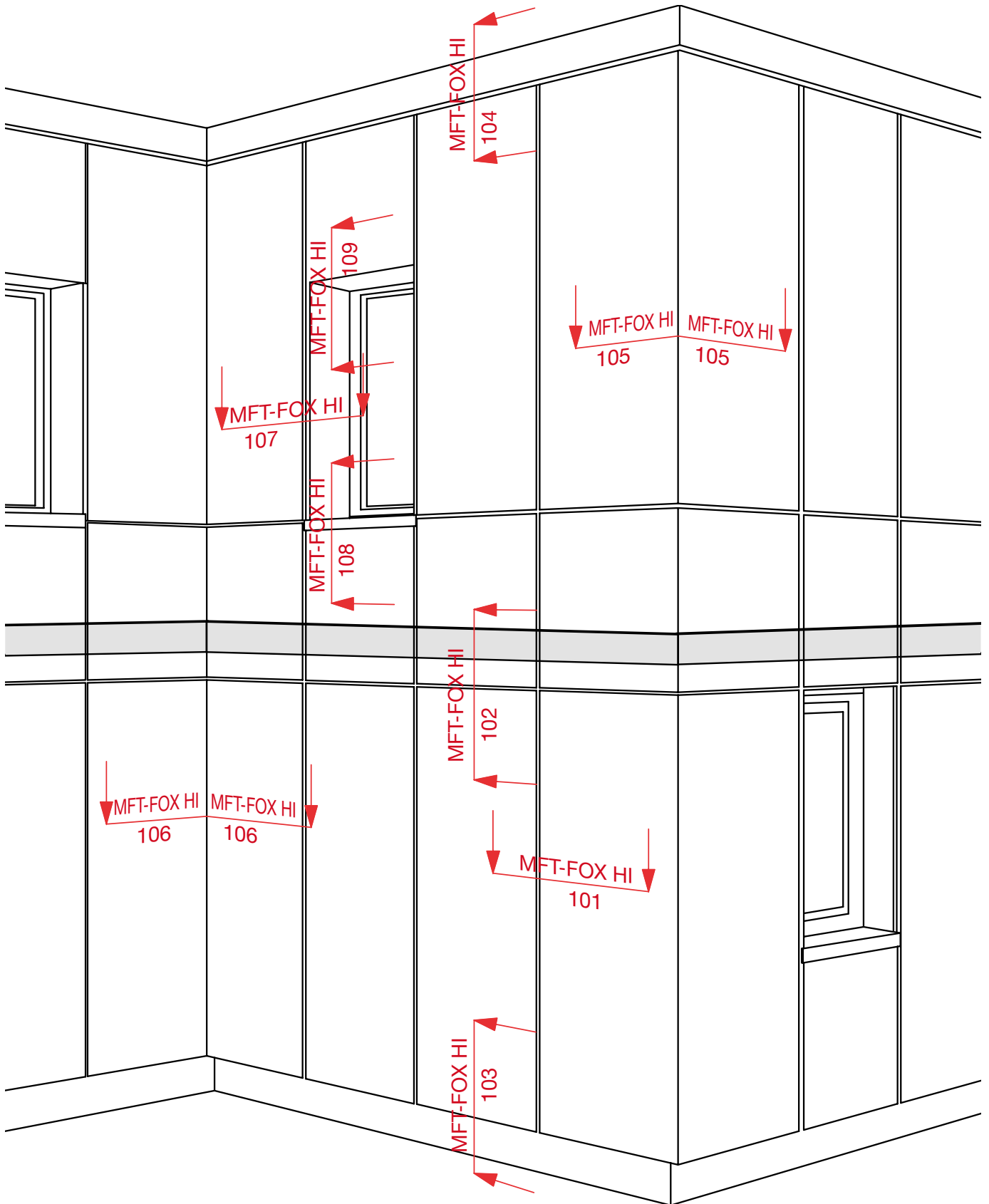

This is an interactive page! By clicking on a system part you get directed to the respective detail page.
Click on the move-back button to jump back to the CONTENT AND OVERVIEW.



MFT-FOX HI 101

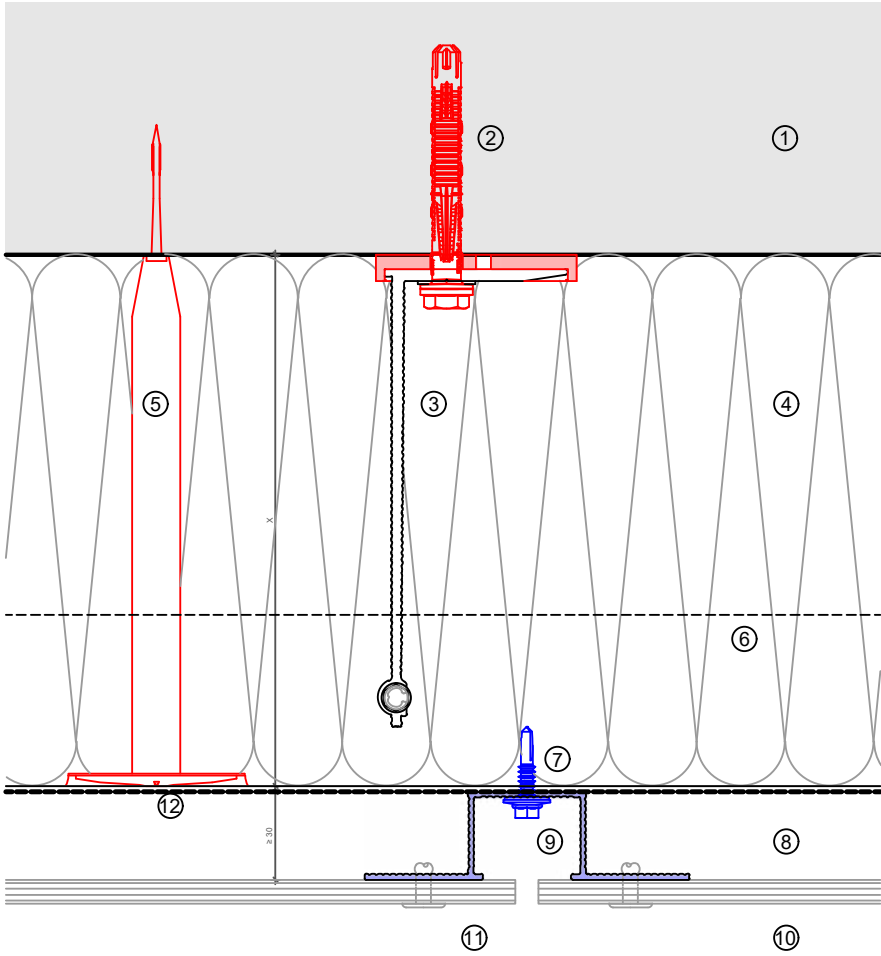

Legend:

- ① Base material
- ② Anchor acc. to static
- ③ Bracket and isolator
- ④ Insulation
- ⑤ Fixing insulation
- ⑥ Profile
- ⑦ Self drilling screw
- ⑧ Ventilation gap
- ⑨ Profile
- ⑩ Cladding
- ⑪ Fixing cladding
- ⑫ Wind membrane

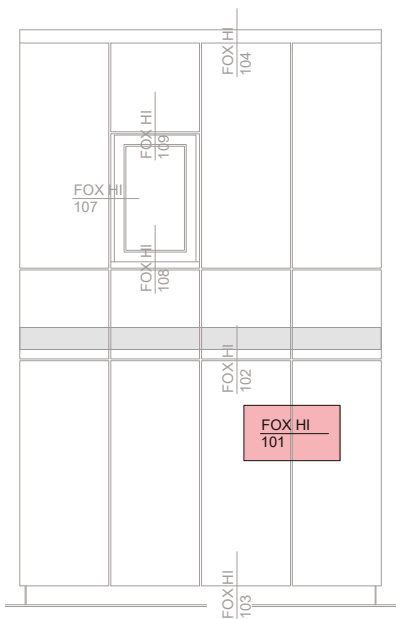

This is an interactive page! Click on the move-back button to jump back to the VIEW OF CLADDING.

MFT-FOX HI 102

Legend:

- ① Base material
- ② Anchor acc. to static
- ③ Bracket and isolator
- ④ Insulation
- ⑤ Fixing insulation
- ⑥ Profile
- ⑦ Self drilling screw
- ⑧ Ventilation gap
- ⑨ Profile
- ⑩ Cladding
- ⑪ Fixing cladding
- ⑫ Wind membrane

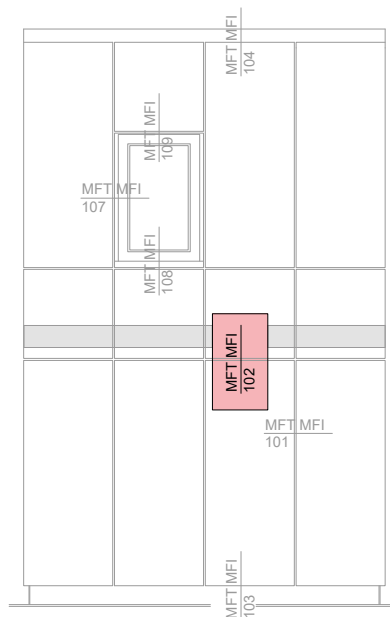
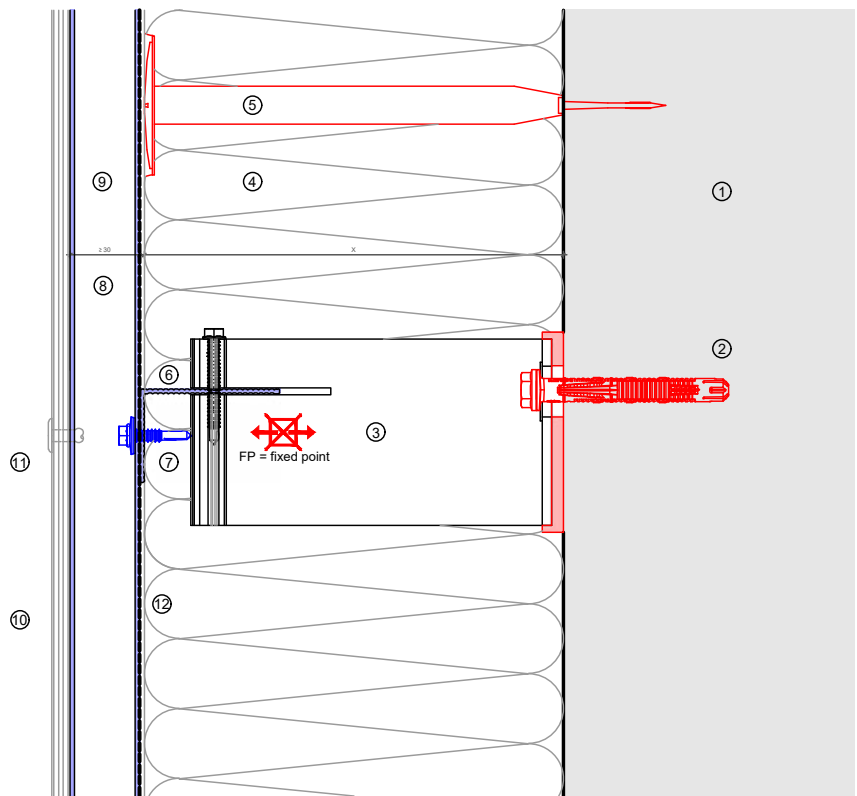

This is an interactive page! Click on the move-back button to jump back to the VIEW OF CLADDING.



MFT-FOX HI 102

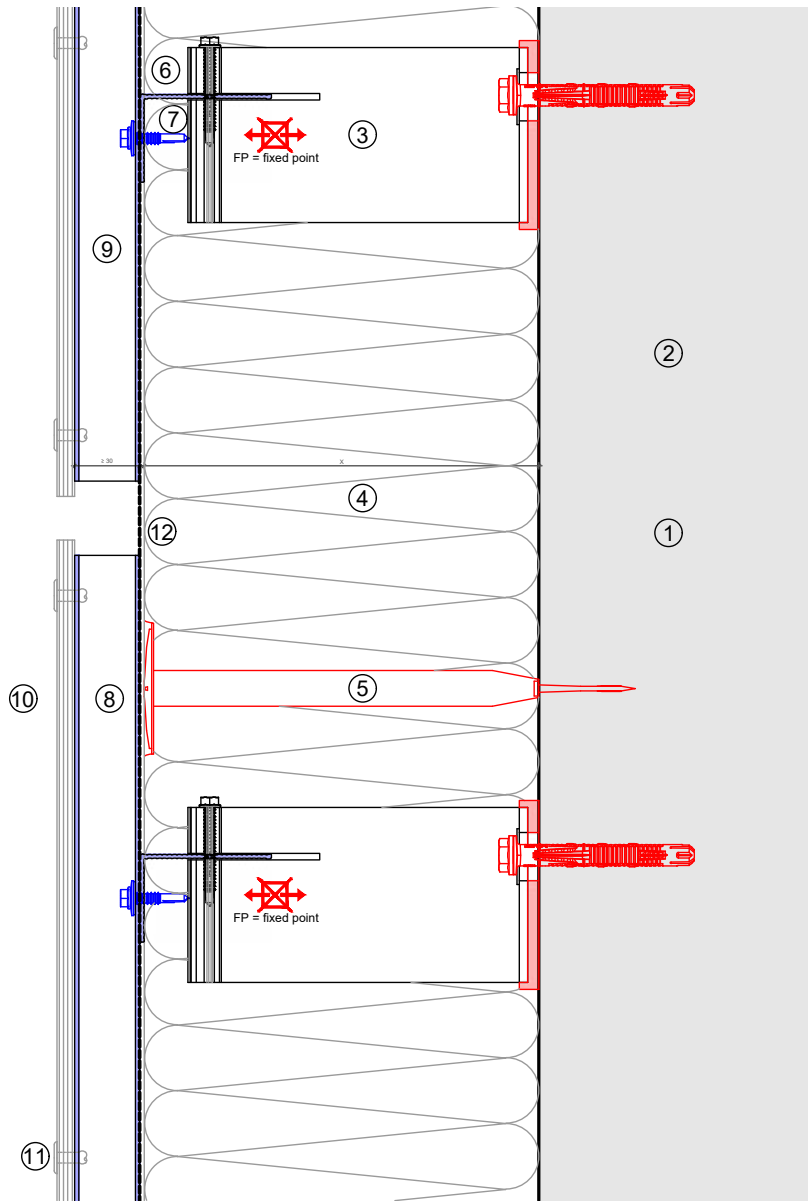

Legend:

- ① Base material
- ② Anchor acc. to static
- ③ Bracket and isolator
- ④ Insulation
- ⑤ Fixing insulation
- ⑥ Profile
- ⑦ Self drilling screw
- ⑧ Ventilation gap
- ⑨ Profile
- ⑩ Cladding
- ⑪ Fixing cladding
- ⑫ Wind membrane

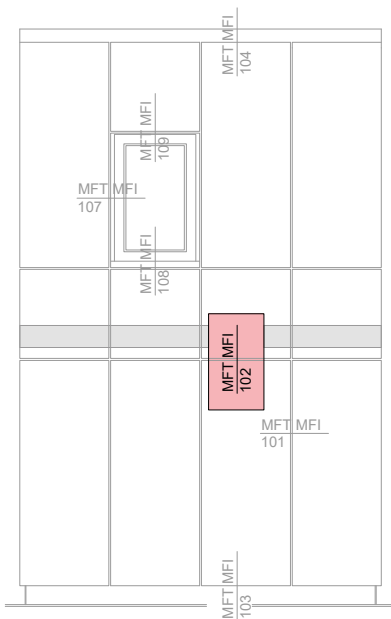

This is an interactive page! Click on the move-back button to jump back to the VIEW OF CLADDING.

MFT-FOX HI 104

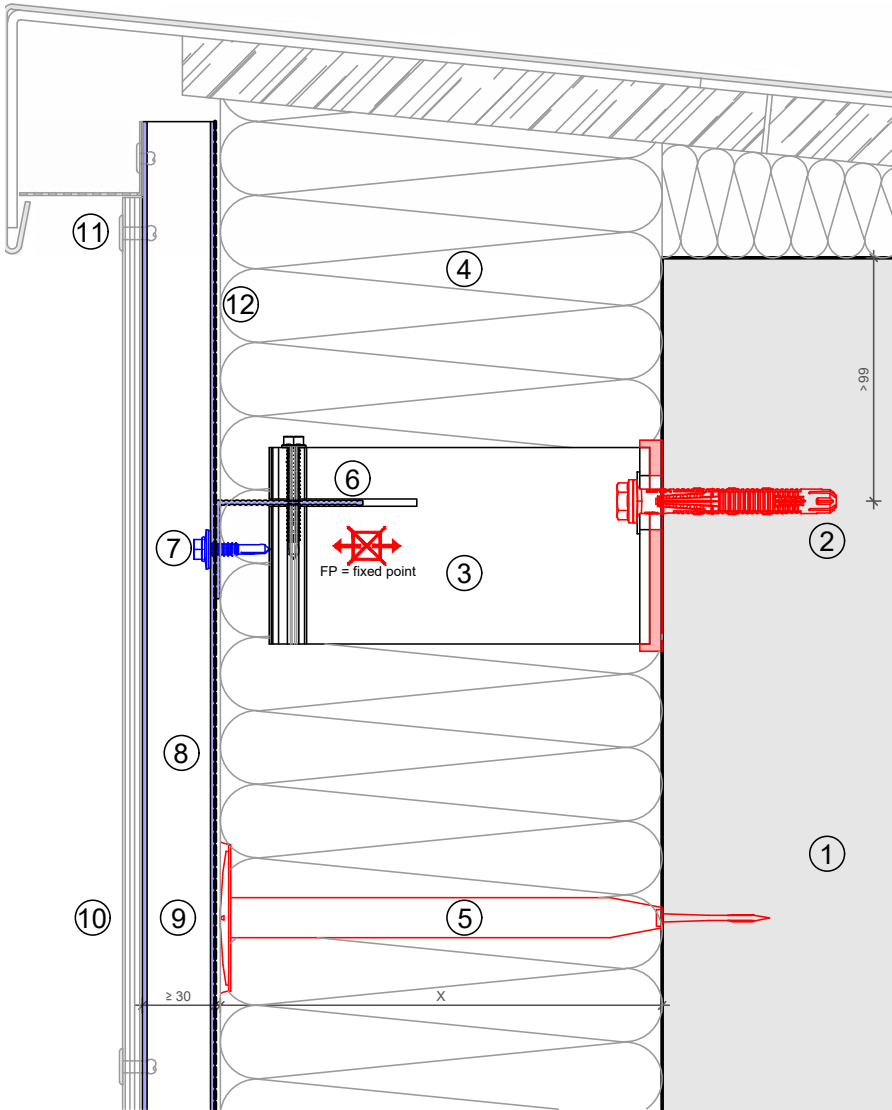

Legend:

- ① Base material
- ② Anchor acc. to static
- ③ Bracket and isolator
- ④ Insulation
- ⑤ Fixing insulation
- ⑥ Profile
- ⑦ Self drilling screw
- ⑧ Ventilation gap
- ⑨ Profile
- ⑩ Cladding
- ⑪ Fixing cladding
- ⑫ Wind membrane

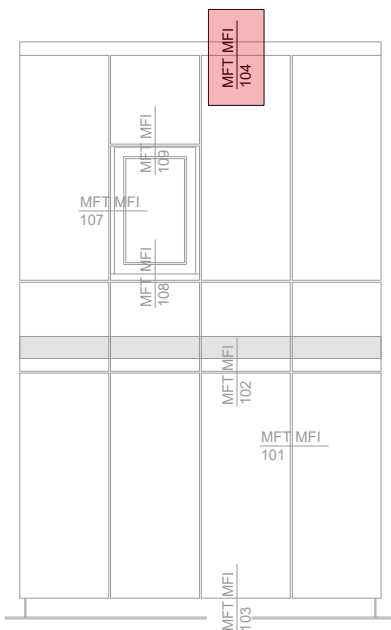

This is an interactive page! Click on the move-back button to jump back to the VIEW OF CLADDING.

MFT-FOX HI 105

Legend:

- ① Base material
- ② Anchor acc. to static
- ③ Bracket and isolator
- ④ Insulation
- ⑤ Fixing insulation
- ⑥ Profile
- ⑦ Profile
- ⑧ Ventilation gap
- ⑨ Self drilling screw
- ⑩ Cladding
- ⑪ Fixing cladding
- ⑫ Wind membrane

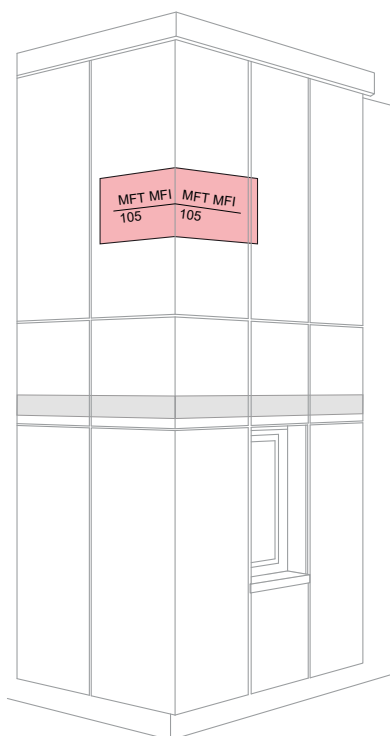
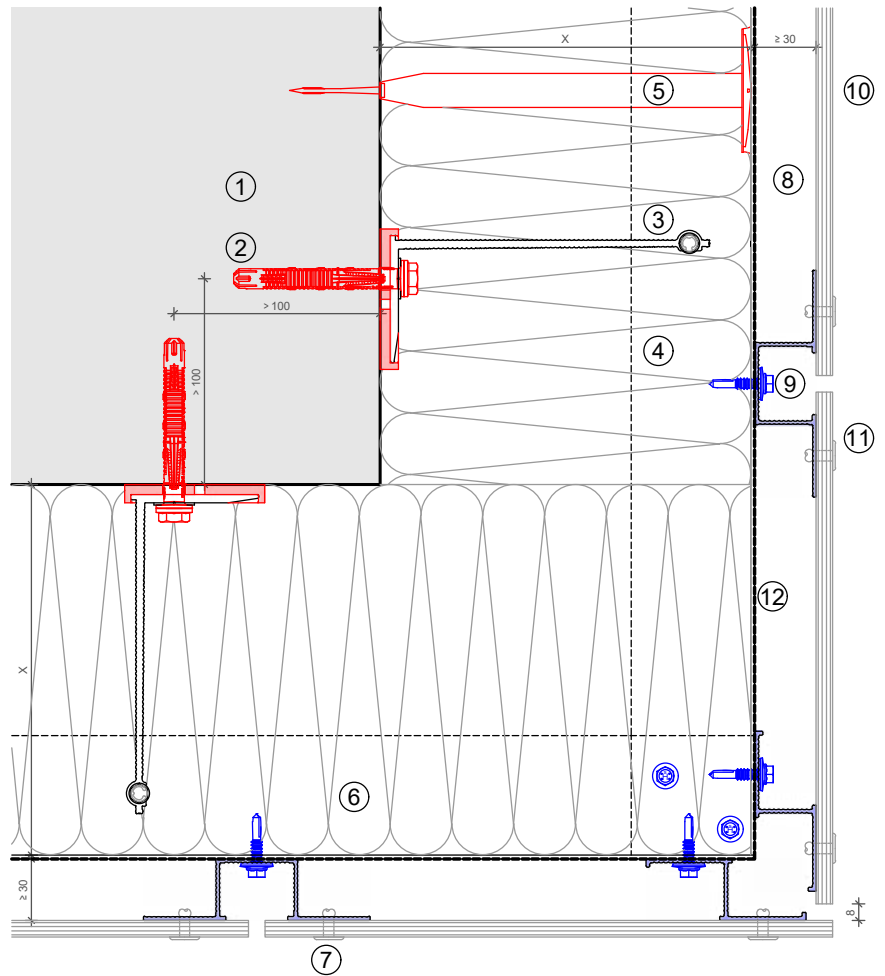

This is an interactive page! Click on the move-back button to jump back to the VIEW OF CLADDING.



MFT-FOX HI 106

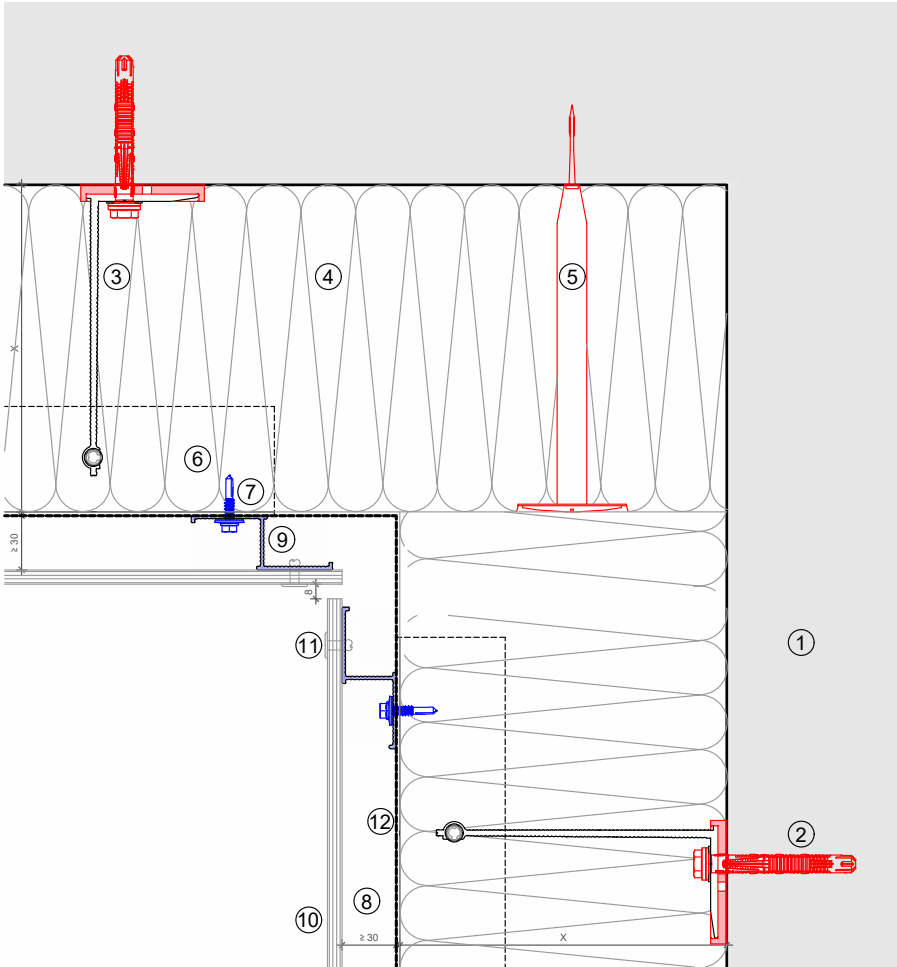

Legend:

- ① Base material
- ② Anchor acc. to static
- ③ Bracket and isolator
- ④ Insulation
- ⑤ Fixing insulation
- ⑥ Profile
- ⑦ Self drilling screw
- ⑧ Ventilation gap
- ⑨ Profile
- ⑩ Cladding
- ⑪ Fixing cladding
- ⑫ Wind membrane



This is an interactive page! Click on the move-back button to jump back to the VIEW OF CLADDING.

MFT-FOX HI 107

Legend:

- ① Base material
- ② Anchor acc. to static
- ③ Bracket and isolator
- ④ Insulation
- ⑤ Fixing insulation
- ⑥ Profile
- ⑦ Self drilling screw
- ⑧ Ventilation gap
- ⑨ Profile
- ⑩ Cladding
- ⑪ Fixing cladding
- ⑫ Wind membrane

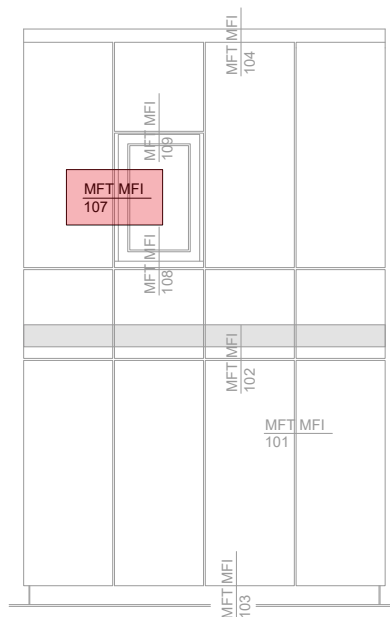
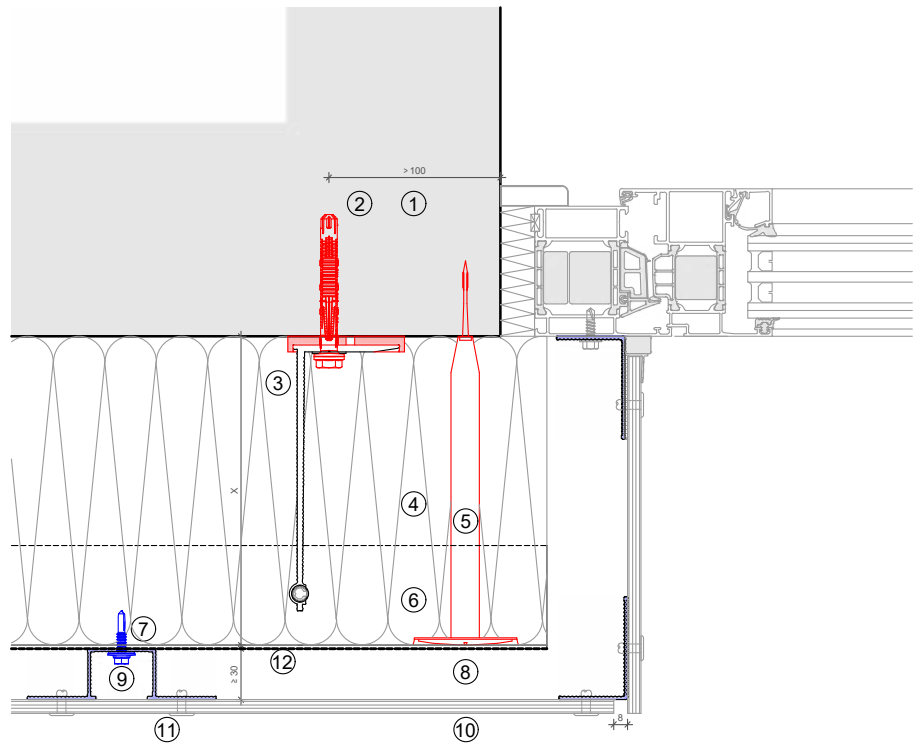

This is an interactive page! Click on the move-back button to jump back to the VIEW OF CLADDING.



MFT-FOX HI 107

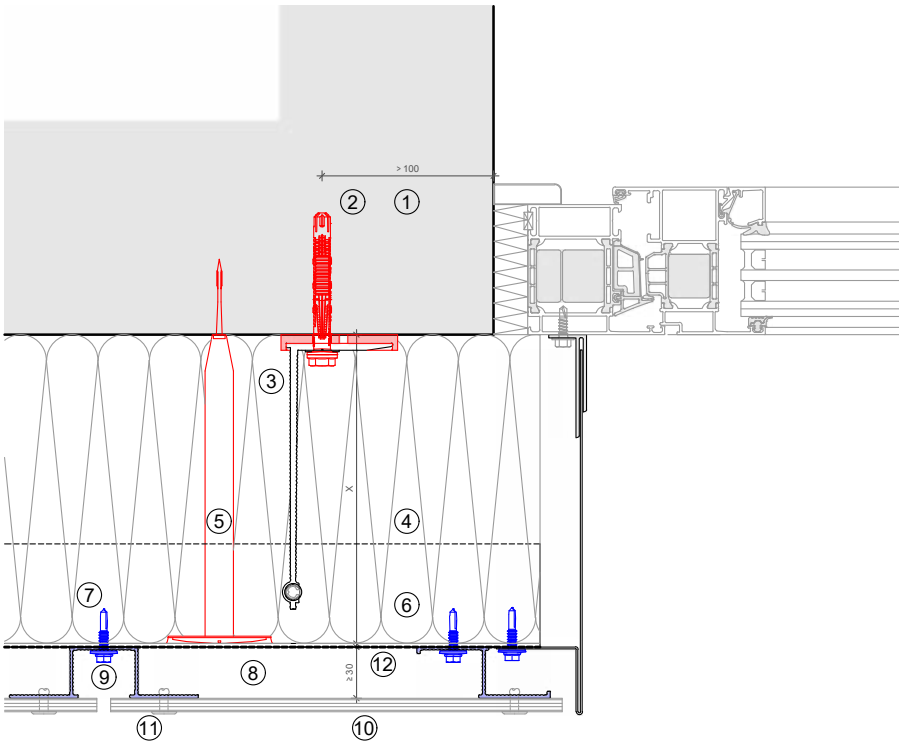

Legend:

- ① Base material
- ② Anchor acc. to static
- ③ Bracket and isolator
- ④ Insulation
- ⑤ Fixing insulation
- ⑥ Profile
- ⑦ Self drilling screw
- ⑧ Ventilation gap
- ⑨ Profile
- ⑩ Cladding
- ⑪ Fixing cladding
- ⑫ Wind membrane

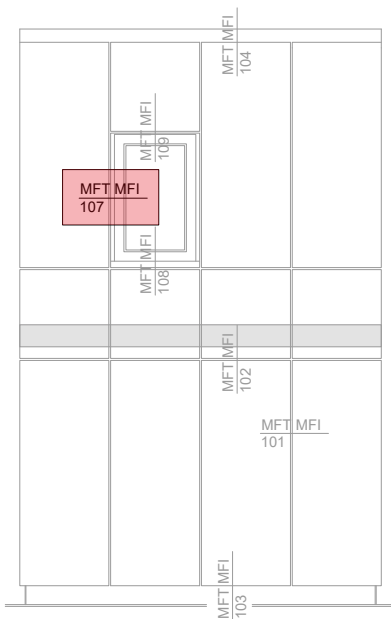

This is an interactive page! Click on the move-back button to jump back to the VIEW OF CLADDING.

MFT-FOX HI 108

Legend:

- ① Base material
- ② Anchor acc. to static
- ③ Bracket and isolator
- ④ Insulation
- ⑤ Fixing insulation
- ⑥ Profile
- ⑦ Self drilling screw
- ⑧ Ventilation gap
- ⑨ Profile
- ⑩ Cladding
- ⑪ Fixing cladding
- ⑫ Wind membrane

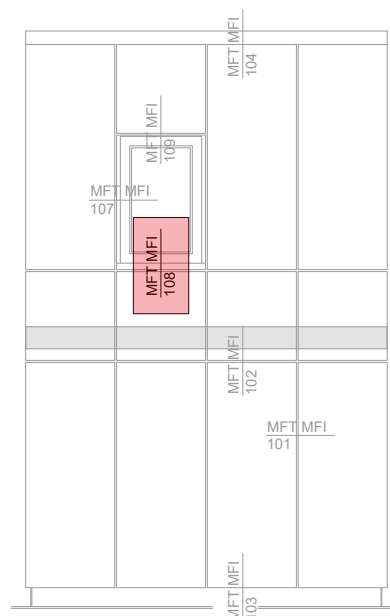
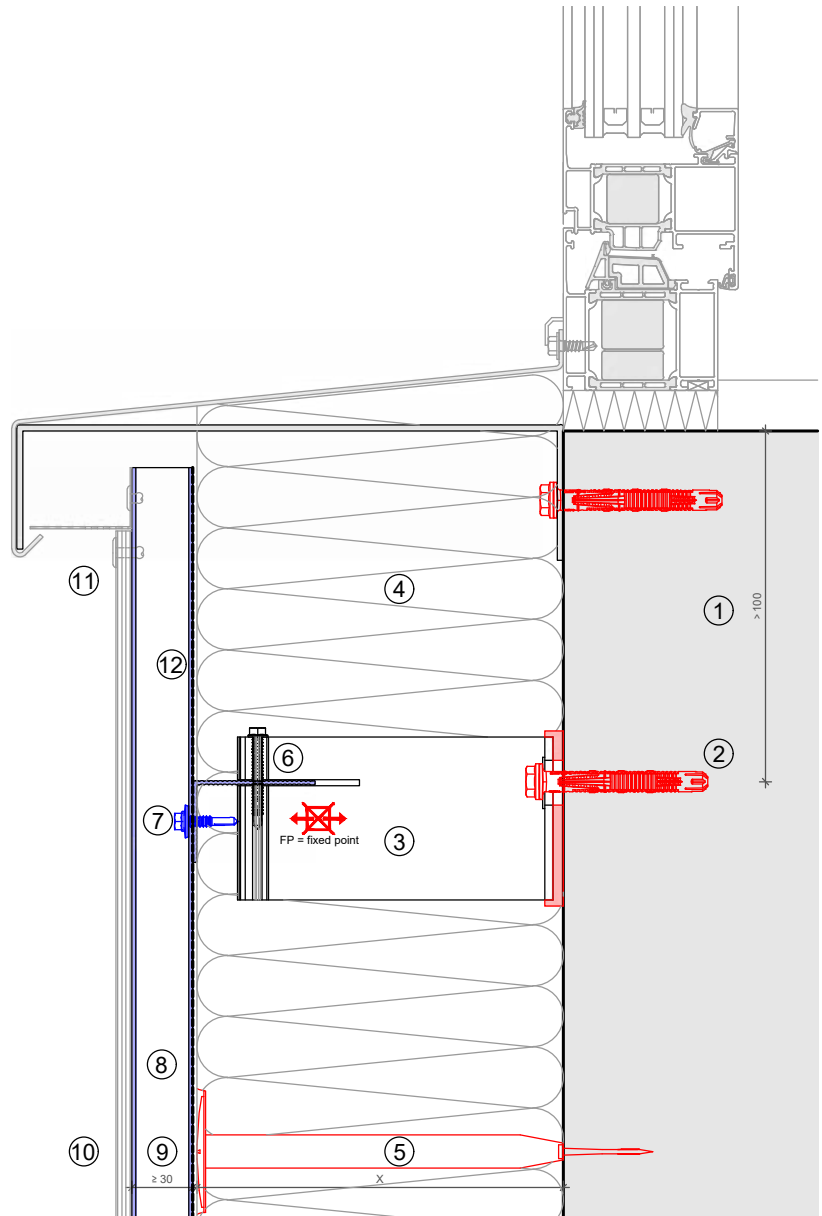

This is an interactive page! Click on the move-back button to jump back to the VIEW OF CLADDING.

MFT-FOX HI 109

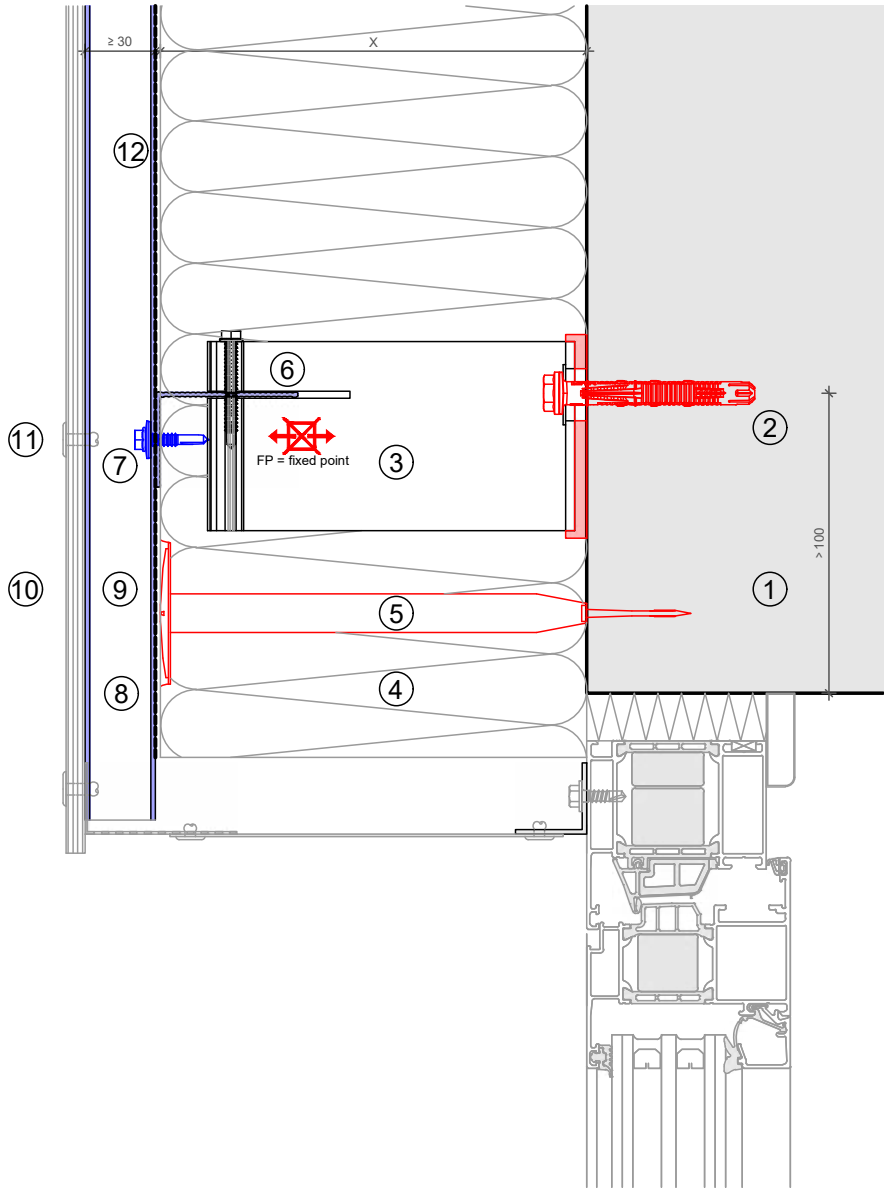

Legend:

- ① Base material
- ② Anchor acc. to static
- ③ Bracket and isolator
- ④ Insulation
- ⑤ Fixing insulation
- ⑥ Profile
- ⑦ Self drilling screw
- ⑧ Ventilation gap
- ⑨ Profile
- ⑩ Cladding
- ⑪ Fixing cladding
- ⑫ Wind membrane

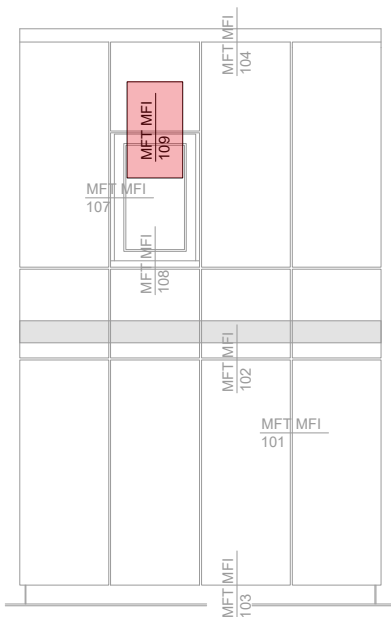

This is an interactive page! Click on the move-back button to jump back to the VIEW OF CLADDING.

MFT-FOX HI 109

Legend:

- ① Base material
- ② Anchor acc. to static
- ③ Bracket and isolator
- ④ Insulation
- ⑤ Fixing insulation
- ⑥ Profile
- ⑦ Self drilling screw
- ⑧ Ventilation gap
- ⑨ Profile
- ⑩ Cladding
- ⑪ Fixing cladding
- ⑫ Wind membrane

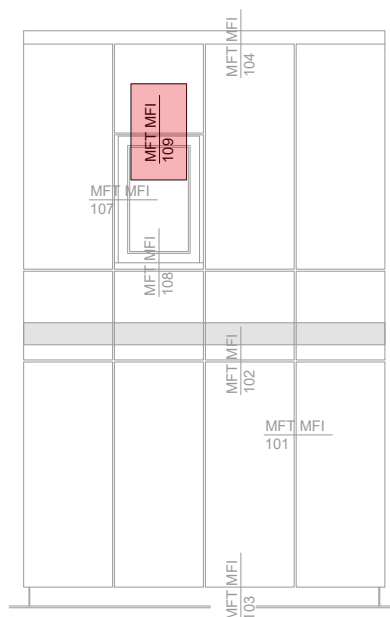
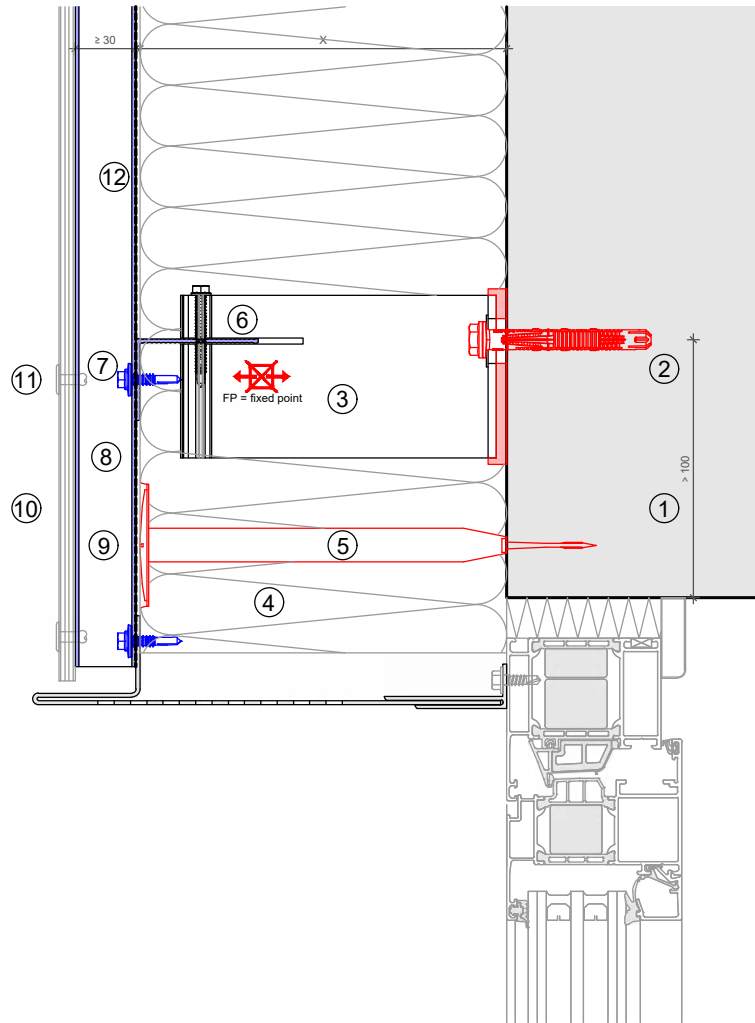

This is an interactive page! Click on the move-back button to jump back to the VIEW OF CLADDING.



MFT-FOX HI 109

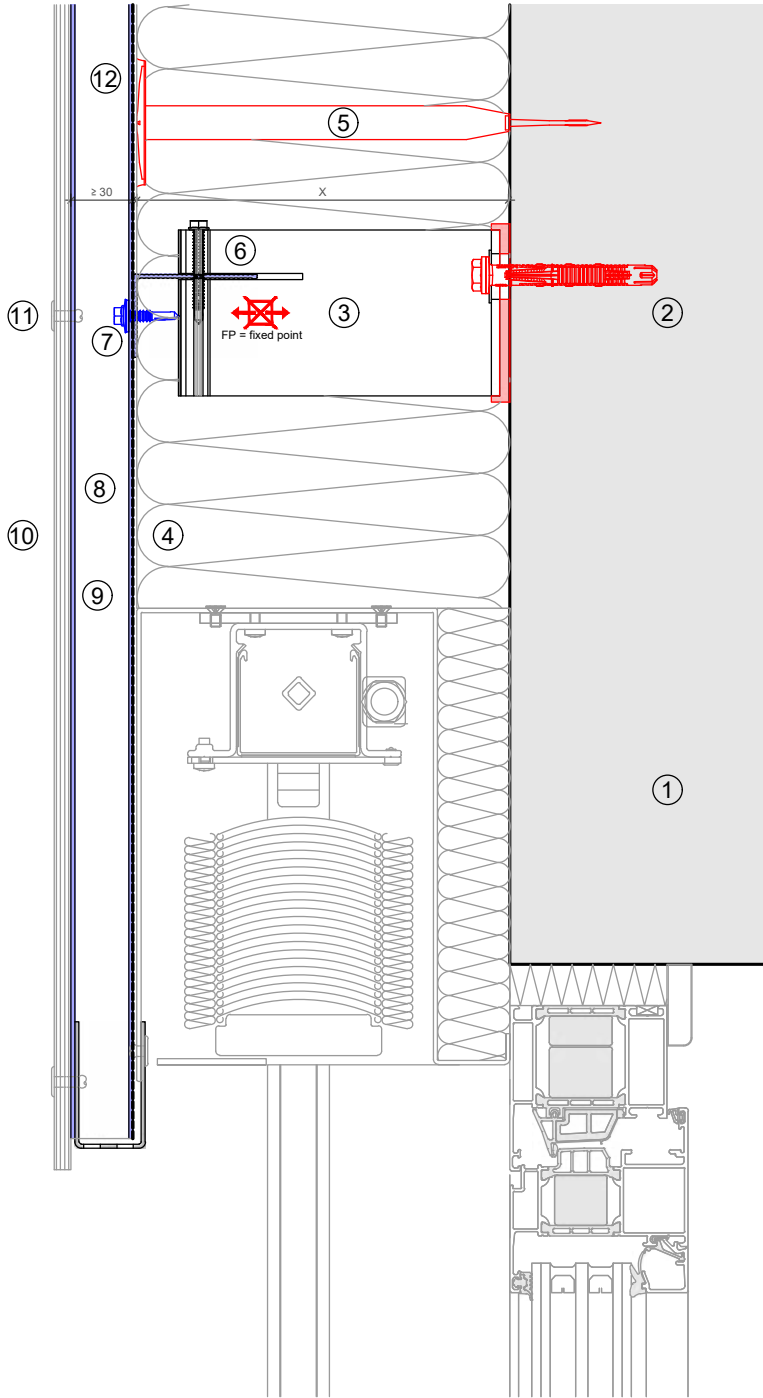

Legend:

- ① Base material
- ② Anchor acc. to static
- ③ Bracket and isolator
- ④ Insulation
- ⑤ Fixing insulation
- ⑥ Profile
- ⑦ Self drilling screw
- ⑧ Ventilation gap
- ⑨ Profile
- ⑩ Cladding
- ⑪ Fixing cladding
- ⑫ Wind membrane

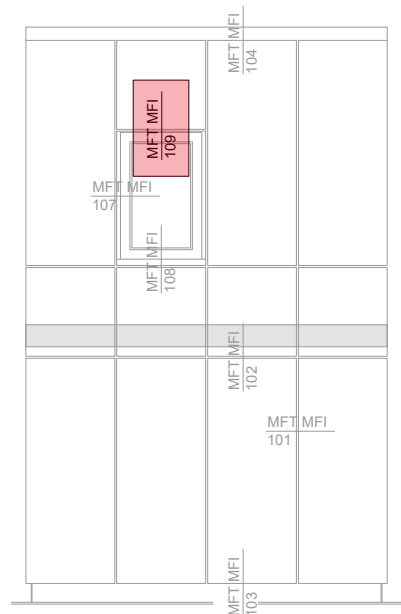

This is an interactive page! Click on the move-back button to jump back to the VIEW OF CLADDING.

BRACKETS RANGE

MFT-FOX HI Medium

Order Description	Item No.	Length
DIRECT FASTENING D=5 mm		
MFT-FOX HI 60 M 5	2084229	60 mm
MFT-FOX HI 80 M 5	2084322	80 mm
MFT-FOX HI 100 M 5	2084325	100 mm
MFT-FOX HI 120 M 5	2084328	120 mm
MFT-FOX HI 140 M 5	2084331	140 mm
MFT-FOX HI 160 M 5	2084334	160 mm
MFT-FOX HI 180 M 5	2084337	180 mm
MFT-FOX HI 200 M 5	2084340	200 mm
MFT-FOX HI 220 M 5	2084343	220 mm
MFT-FOX HI 240 M 5	2084346	240 mm
MFT-FOX HI 260 M 5	2084349	260 mm
MFT-FOX HI 280 M 5	2084352	280 mm
MFT-FOX HI 300 M 5	2084355	300 mm
SCREWS D=6,5 mm		
MFT-FOX HI 60 M 6,5	2084320	60 mm
MFT-FOX HI 80 M 6,5	2084323	80 mm
MFT-FOX HI 100 M 6,5	2084326	100 mm
MFT-FOX HI 120 M 6,5	2084329	120 mm
MFT-FOX HI 140 M 6,5	2084332	140 mm
MFT-FOX HI 160 M 6,5	2084335	160 mm
MFT-FOX HI 180 M 6,5	2084338	180 mm
MFT-FOX HI 200 M 6,5	2084341	200 mm
MFT-FOX HI 220 M 6,5	2084344	220 mm
MFT-FOX HI 240 M 6,5	2084347	240 mm
MFT-FOX HI 260 M 6,5	2084350	260 mm
MFT-FOX HI 280 M 6,5	2084353	280 mm
MFT-FOX HI 300 M 6,5	2084356	300 mm

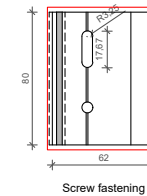
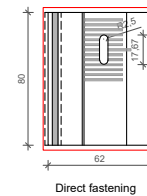
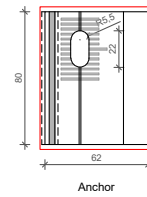
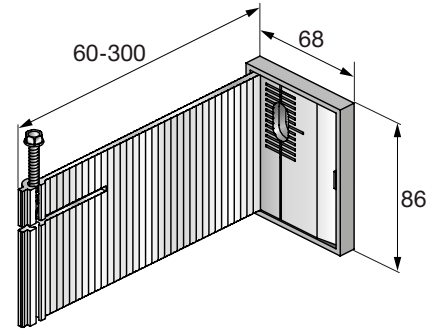

The length shown includes the isolator thickness.



BRACKETS RANGE

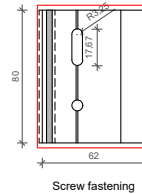
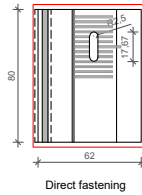
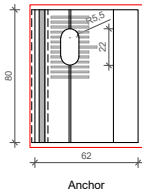
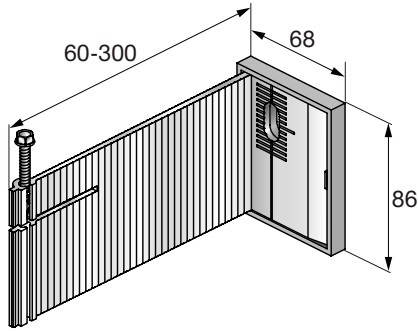

MFT-FOX HI Medium

Order Description	Item No.	Length
ANCHORS D=9 mm		
MFT-FOX HI 60 M 9	2170852	60 mm
MFT-FOX HI 80 M 9	2170853	80 mm
MFT-FOX HI 100 M 9	2170854	100 mm
MFT-FOX HI 120 M 9	2170855	120 mm
MFT-FOX HI 140 M 9	2170856	140 mm
MFT-FOX HI 160 M 9	2170857	160 mm
MFT-FOX HI 180 M 9	2170858	180 mm
MFT-FOX HI 200 M 9	2170859	200 mm
MFT-FOX HI 220 M 9	2170860	220 mm
MFT-FOX HI 240 M 9	2170861	240 mm
MFT-FOX HI 260 M 9	2170862	260 mm
MFT-FOX HI 280 M 9	2170863	280 mm
MFT-FOX HI 300 M 9	2170864	300 mm
ANCHORS D=11 mm		
MFT-FOX HI 60 M 11	2084321	60 mm
MFT-FOX HI 80 M 11	2084324	80 mm
MFT-FOX HI 100 M 11	2084327	100 mm
MFT-FOX HI 120 M 11	2084330	120 mm
MFT-FOX HI 140 M 11	2084333	140 mm
MFT-FOX HI 160 M 11	2084336	160 mm
MFT-FOX HI 180 M 11	2084339	180 mm
MFT-FOX HI 200 M 11	2084342	200 mm
MFT-FOX HI 220 M 11	2084345	220 mm
MFT-FOX HI 240 M 11	2084348	240 mm
MFT-FOX HI 260 M 11	2084351	260 mm
MFT-FOX HI 280 M 11	2084354	280 mm
MFT-FOX HI 300 M 11	2084357	300 mm

The length shown includes the isolator thickness.



This is an interactive page! Click on the move-back button to jump back to the CONTENT AND OVERVIEW.

BRACKET PROFILE ADJUSTMENT

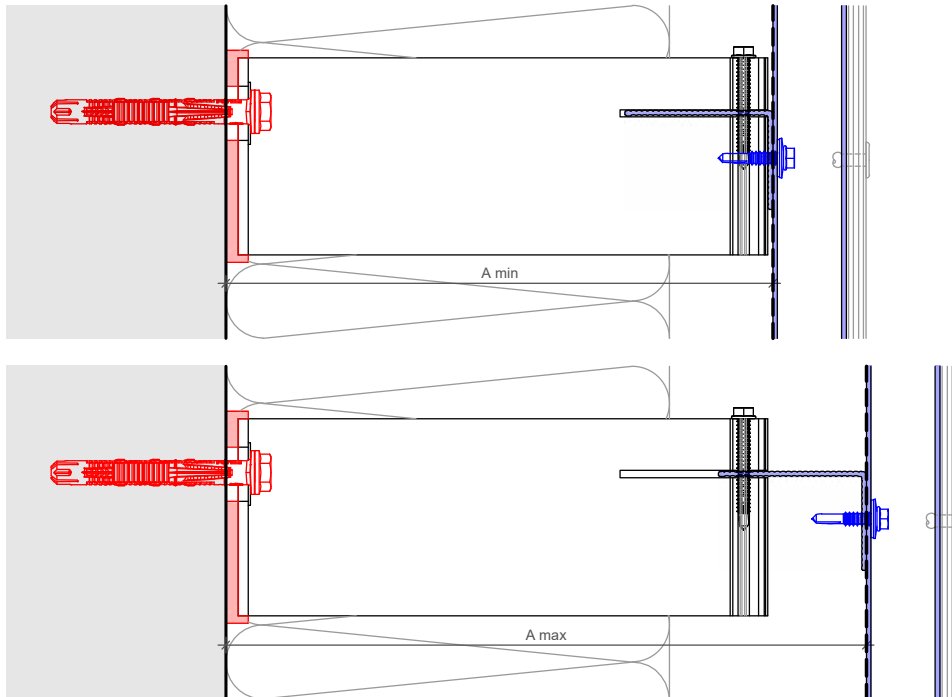

Profiles	MFT-T 60x80x1,8 6m 60x100x1,8 6m 60x120x1,8 6m		MFT-T 40x80x1,8 6m		MFT-L 60x40x1,8 6m		MFT-L 40x40x1,8 6m	
	A min*	A max*	A min*	A max*	A min*	A max*	A min*	A max*
Brackets								
MFT-FOX HI 60 M 5/6,5/11	69	101.8	61.8	81.8	69	101.8	61.8	81.8
MFT-FOX HI 80 M 5/6,5/11	81.8	121.8	81.8	101.8	81.8	121.8	81.8	101.8
MFT-FOX HI 100 M 5/6,5/11	101.8	141.8	101.8	121.8	101.8	141.8	101.8	121.8
MFT-FOX HI 120 M 5/6,5/11	121.8	161.8	121.8	141.8	121.8	161.8	121.8	141.8
MFT-FOX HI 140 M 5/6,5/11	141.8	181.8	141.8	161.8	141.8	181.8	141.8	161.8
MFT-FOX HI 160 M 5/6,5/11	161.8	201.8	161.8	181.8	161.8	201.8	161.8	181.8
MFT-FOX HI 180 M 5/6,5/11	181.8	221.8	181.8	201.8	181.8	221.8	181.8	201.8
MFT-FOX HI 200 M 5/6,5/11	201.8	241.8	201.8	221.8	201.8	241.8	201.8	221.8
MFT-FOX HI 220 M 5/6,5/11	221.8	261.8	221.8	241.8	221.8	261.8	221.8	241.8
MFT-FOX HI 240 M 5/6,5/11	241.8	281.8	241.8	261.8	241.8	281.8	241.8	261.8
MFT-FOX HI 260 M 5/6,5/11	261.8	301.8	261.8	181.8	261.8	301.8	261.8	181.8
MFT-FOX HI 280 M 5/6,5/11	281.8	321.8	281.8	301.8	281.8	321.8	281.8	301.8
MFT-FOX HI 300 M 5/6,5/11	301.8	341.8	301.8	321.8	301.8	341.8	301.8	321.8

* The distance shown is valid for profile of 1,8 mm.



PRODUCTS RANGE

Bracket fasteners

HUS-HR



HRD-H



HST-R



HSA-R



HIT-HY 270



HIT-HY 200-A



S-MP 53S



S-MD 51S / S-MD 53S / S-MD 55S



Direct fastening



Brackets

MFT-FOX HI Medium



PRODUCTS RANGE

Profiles

MFT-L



MFT-T



MFT-O



MFT-Z



Profile fastener

S-AD



Accessories

MFT-ISO



Insulation fasteners

Insulation fasteners

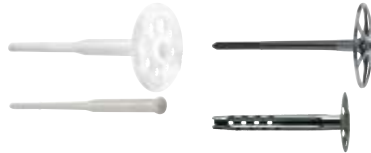



Hilti Corporation
9494 Schaan Liechtenstein
P +423-234 2111

www.facebook.com/hiltigroup
www.hilti.group